

GEARING UP FOR SAFETY

SAFE WORK PRACTICES FOR COMMERCIAL FISHING IN BRITISH COLUMBIA



WORK SAFE BC

WORKING TO MAKE A DIFFERENCE
worksafebc.com

BANKS ISLAND	
TABLE 1	
TIDE GAUGE DATA	
Station	Mean
11110	11.70
11111	11.70
11112	11.70
11113	11.70
11114	11.70
11115	11.70
11116	11.70
11117	11.70
11118	11.70
11119	11.70
11120	11.70
11121	11.70
11122	11.70
11123	11.70
11124	11.70
11125	11.70
11126	11.70
11127	11.70
11128	11.70
11129	11.70
11130	11.70
11131	11.70
11132	11.70
11133	11.70
11134	11.70
11135	11.70
11136	11.70
11137	11.70
11138	11.70
11139	11.70
11140	11.70
11141	11.70
11142	11.70
11143	11.70
11144	11.70
11145	11.70
11146	11.70
11147	11.70
11148	11.70
11149	11.70
11150	11.70
11151	11.70
11152	11.70
11153	11.70
11154	11.70
11155	11.70
11156	11.70
11157	11.70
11158	11.70
11159	11.70
11160	11.70
11161	11.70
11162	11.70
11163	11.70
11164	11.70
11165	11.70
11166	11.70
11167	11.70
11168	11.70
11169	11.70
11170	11.70
11171	11.70
11172	11.70
11173	11.70
11174	11.70
11175	11.70
11176	11.70
11177	11.70
11178	11.70
11179	11.70
11180	11.70
11181	11.70
11182	11.70
11183	11.70
11184	11.70
11185	11.70
11186	11.70
11187	11.70
11188	11.70
11189	11.70
11190	11.70
11191	11.70
11192	11.70
11193	11.70
11194	11.70
11195	11.70
11196	11.70
11197	11.70
11198	11.70
11199	11.70
11200	11.70

About WorkSafeBC

WorkSafeBC (the Workers' Compensation Board) is an independent provincial statutory agency governed by a Board of Directors. It is funded by insurance premiums paid by registered employers and by investment returns. In administering the *Workers Compensation Act*, WorkSafeBC remains separate and distinct from government; however, it is accountable to the public through government in its role of protecting and maintaining the overall well-being of the workers' compensation system.

WorkSafeBC was born out of a compromise between B.C.'s workers and employers in 1917 where workers gave up the right to sue their employers or fellow workers for injuries on the job in return for a no-fault insurance program fully paid for by employers. WorkSafeBC is committed to a safe and healthy workplace, and to providing return-to-work rehabilitation and legislated compensation benefits to workers injured as a result of their employment.

WorkSafeBC Prevention Information Line

The WorkSafeBC Prevention Information Line can answer your questions about workplace health and safety, worker and employer responsibilities, and reporting a workplace accident or incident. The Prevention Information Line accepts anonymous calls.

Phone 604 276-3100 in the Lower Mainland, or call 1 888 621-7233 (621-SAFE) toll-free in British Columbia.

To report after-hours and weekend accidents and emergencies, call 604 273-7711 in the Lower Mainland, or call 1 866 922-4357 (WCB-HELP) toll-free in British Columbia.

GEARING UP FOR SAFETY

**SAFE WORK PRACTICES FOR COMMERCIAL
FISHING IN BRITISH COLUMBIA**



WORKING TO MAKE A DIFFERENCE
worksafebc.com

WorkSafeBC publications

Gearing Up for Safety is available on the WorkSafeBC website. For a printed copy, contact Fish SAFE at 604 261-9700 or by email at gina@fishsafebc.com.

To purchase copies of other WorkSafeBC publications, DVDs, and videos, contact Customer Services:

Phone 604 232-9704 or

Toll-free 1 866 319-9704

Fax 604 232-9703 or toll-free 1 888 232-9714

E-mail: customer.service@worksafebcstore.com

For more information on workplace health and safety, visit www.WorkSafeBC.com

©1993, 2003, 2012 Workers' Compensation Board of British Columbia. All rights reserved. The Workers' Compensation Board of B.C. encourages the copying, reproduction, and distribution of this document to promote health and safety in the workplace, provided that the Workers' Compensation Board of B.C. is acknowledged. However, no part of this publication may be copied, reproduced, or distributed for profit or other commercial enterprise, nor may any part be incorporated into any other publication, without written permission of the Workers' Compensation Board of B.C.

2012 edition

Library and Archives Canada Cataloguing in Publication Data

Main entry under title:

Gearing up for safety: safe work practices for commercial fishing in British Columbia

Irregular.

ISSN 1705-0227 = Gearing up for safety: safe work practices for commercial fishing in British Columbia

1. Fishing boats - British Columbia – Safety measures – Handbooks, manuals, etc.
2. Fishing – British Columbia – Safety measures – Handbooks, manuals, etc. I. Workers' Compensation Board of British Columbia. II. Title: Safe work practices for commercial fishing in British Columbia.

SH343.9.G47

363.11'96392'09711

C95-960033-7

Fish SAFE's role in BC fishing safety

Fish SAFE is a fishing industry program funded by the B.C. fishing industry and administered by the BC Seafood Alliance. All programs are developed and driven by fishermen for fishermen for the purpose of reducing injuries and fatalities.

On behalf of the fishing industry, Fish SAFE coordinates and develops safety tools and programs for fishermen by:

- Serving as an advocate for health and safety within the fishing industry
- Coordinating industry advice to regulatory agencies on health and safety issues and regulations
- Developing training tools for fishermen
- Monitoring and communicating accident patterns
- Improving safety awareness and procedures on board vessels
- Coordinating the B.C. Fish SAFE Advisory Committee and seminars on safety

Fish SAFE also works with WorkSafeBC to bring clarity to the process of claims and reduce overall costs to the industry.

This is accomplished through:

- Providing fishing industry orientations for WorkSafeBC staff
- Reviewing all relevant WorkSafeBC reports on claims in the fishing classification units and following up on claims where advisable
- Acting as liaison between the injured workers, individual vessel owners, fish buyers, and WorkSafeBC case managers dedicated to the fishing classification units
- Encouraging vessel owners to actively manage claims

Fish SAFE Advisory Committee

The Fish SAFE Advisory Committee is the B.C. forum for fishing vessel safety. The committee reviews issues around safety and provides direction for recommendations and tools. The committee is open to all fishermen, and members are appointed by their sector or association. This makes them responsible to report on safety issues to the committee and take information back to industry. Meetings are always well attended and supported by technical experts and ex-officio members from the Transportation Safety Board, Transport Canada, Department of Fisheries and Oceans, Canada Coast Guard, and WorkSafeBC.

For more information on fishing industry safety programs such as Fish SAFE Stability Education, Safe on the Wheel, and Safest Catch, contact:



2-11771 Horseshoe Way, Richmond, BC V7A 4V4

Phone: 604 261-9700 • Fax: 604 275-7140

Email: gina@fishsafebc.com • Website: www.fishsafebc.com

Acknowledgments

The revision of this manual would not have been possible without the assistance of the fishing industry. In particular, we would like to thank Fish SAFE and the Fish SAFE Advisory Committee for their valuable input. We would also like to express our gratitude to Fish SAFE for many of the photographs used on the divider pages and to the crew of the *Viking Storm* for the cover photo.

To all who participated in this project, our many thanks.

Contents

Introduction

Injuries in the fishing industry	1
Safety responsibilities	2
Vessel owners and masters	2
Vessel owners	2
Vessel masters	2
Crew	3

Safe at Sea

Emergency preparedness and procedures	7
Emergency drills	7
Cold water survival	9
Abandoning ship safely	10
Vessel stability	11
Prior to sailing	11
Threats to stability	11
Fatigue	14

Safety Procedures

General health and safety requirements	17
Hazard identification	17
Risk assessment	17
Safety procedures	17
Crew training	17
Safety talks with crew	18
Regular inspections	18
Maintenance	18
Housekeeping	18
Records	18
Incident and accident investigations	18
Report serious incidents	18
Safety for all vessels and crew	19
General safety	19
Deck	23
Engine room	25
Fall protection	27
Fish handling operations	28
Galley	30
Confined spaces	32
Workplace Hazardous Materials Information System (WHMIS)	33
Hoists and rigging	34
Machinery	39
Documentation	41

Safety Equipment

First aid	45
Ventilation	47
Ozone safety	48
Life rafts	49
Personal protective equipment	50
Personal flotation devices (PFDs) and life jackets	50
Immersion suits	50
Head, eye and face protection	51
Hand protection	52
Footwear	53
Hearing protection	53
Sensors and alarms	54

Safety by Gear

Dive	59
Scuba diving	61
Surface-supplied diving	63
Gillnet	65
Longline	69
Packing	71
Seine	74
Beachline operations	79
Brailing procedures	84
Trap	86
Trawl	88
Troll	93

Claims, Investigations, and Insurance

Who is covered by WorkSafeBC?	97
Reporting accidents to WorkSafeBC	98
Filing a claim	99
Teleclaim contact centre	100
Assistance with claims	101
Fishing incident investigation report	102

Appendices

Appendix A: Injuries and claims in commercial fishing	109
Appendix B: Sample vessel checklist	113
Appendix C: Conducting a risk assessment in commercial fishing	114
Appendix D: For more information	116

Introduction

Commercial fishing is one of the most dangerous occupations in British Columbia. Each year, loss of life continues and many fishermen are seriously injured. Paralysis. Amputations. Broken bones. Muscle strains. Back injuries. Cuts and bruises. Burns and scalds. Hearing loss. Death. Most of these can be prevented.

Gearing Up for Safety addresses many common safety and health hazards in the commercial fishing industry in B.C. waters. It is not meant to replace the Occupational Health and Safety Regulation.

Most of what you will read in *Gearing Up for Safety* is common sense. But even common sense is worth repeating. For example, wearing life jackets, carrying the right safety equipment, and making sure all deckhands know how to start and stop the machinery are key safety steps that can save lives and prevent injuries.

You may have questions about some of the requirements or about situations specific to your vessel. Answers will be provided by WorkSafeBC officers who visit you on board your vessel, or by calling our toll-free number: **1 888 621-SAFE (7233)**.

This manual was produced by WorkSafeBC in collaboration with Fish SAFE, and other fishing industry representatives. The safety steps included here are a direct result of industry input, and reflect what are commonly seen in B.C. waters as safe work practices.

Working together, we can help make commercial fishing in B.C. safer for everyone.

Using this manual

This manual has been designed to be easy to read and understand. We have tried to make this a resource you will keep on hand and use often.

Although some parts of the manual are aimed at specific audiences (e.g., masters and crew on particular types of boats), it contains information for all vessel owners, masters, and crew – anyone who has an interest in keeping the commercial fishing industry as safe as possible.

When you see the word **must** (or **must not**) in this manual, it means a particular safety procedure is required by the Occupational Health and Safety Regulation. When you see the word **should**, it means a good or recommended practice, basically a tip for fishermen. This manual is not meant to replace the Regulation, which changes from time to time. Visit www.WorkSafeBC.com for the most up-to-date information.

Injuries in the fishing industry

Fatalities and serious injuries continue to be significant in the commercial fishing industry. The majority of fatalities are related to drowning. WorkSafeBC and Fish SAFE initiatives are focused on vessel stability, the effects of cold water immersion, and emergency preparedness and drills.

Injuries in commercial fishing tend to be serious, resulting from vessel accidents, crew members being struck by objects, crew members caught in or compressed by equipment, and overexertion. In 2010, 68 percent of the fishing claims were considered serious injury claims by WorkSafeBC's definition.

The most common injuries are sprains, strains, tears, fractures, cuts, lacerations, and bruises or contusions.

For detailed statistics about injuries and claims in this sector, see Appendix A.

Safety responsibilities

Preventing on-the-job injuries and disease is up to everyone. To maintain health and safety in fishing operations, vessel owners, masters, and crew have to accept their individual responsibilities.

Vessel owners and masters

The owner and the master of a fishing vessel are the employer for the purpose of occupational health and safety. See *Workers Compensation Act*, Part 3—Occupational Health and Safety Division 1, Definitions 106 (c).

Vessel owners

Until the vessel is turned over to the master, it's up to the vessel owner to make sure that all required equipment and supplies are on board the main vessel and the skiff (if applicable). In particular, the vessel owner **must** make sure:

- The vessel is in seaworthy condition, and all machinery and equipment on board the fishing vessel performs safely and meets WorkSafeBC requirements. This includes making sure that moving parts of power-operated equipment are properly guarded.
- Documentation and instructions—such as engine room procedures, vessel and equipment characteristics and use (including personal protective equipment), and location and use of firefighting and emergency equipment—is on board and readily accessible to the crew.
- The vessel is fitted with required sensors and alarms.
- All first aid equipment and supplies required by the *Workers Compensation Act* are on board (see Part 3 of the Occupational Health and Safety Regulation: Rights and Responsibilities—Occupational First Aid).

- Any modifications to the vessel do not adversely affect its stability.

Vessel masters

Once the master takes over the vessel, the master is responsible for the safety of everyone on board and for the safe operation of the vessel and its equipment. In particular, the master **must** make sure:

- Machinery and equipment are properly maintained and function safely, and any equipment that is replaced meets WorkSafeBC requirements.
- The vessel is kept in seaworthy condition.
- All crew are trained in safe work procedures. These include training in the safe use of equipment, techniques for lifting, any unusual or unique characteristics of the vessel, and safe work practices for each fishery undertaken.
- All crew are trained and assigned duties for all emergency situations—calling for help, abandoning ship, a crew member falling overboard, flooding, and fire. The master **must** conduct drills at the start of the fishing season and whenever there is a crew change to make sure all crew know emergency duties and how to call for help. The master is also responsible for making sure suitable equipment is on board to rescue a crew member who falls over the side. (See the “Safe at Sea,” tabbed section for more information on emergency drills.)
- All crew are supplied with and use appropriate personal protective equipment, which includes personal flotation devices.
- The vessel is capable of making safe passage before leaving port—this means the vessel **must** be seaworthy. Cargo, skiffs, equipment, fuel containers, and supplies **must** be safely stowed. The vessel **must** be safely ballasted, and present and forecast weather conditions are considered before heading out to sea.

-
- All injuries needing medical aid are reported to the owner, and all injuries are recorded in the vessel log book.
 - An investigation is carried out into incidents resulting in an injury requiring medical aid, or into incidents with the potential for serious injury.
 - Unsafe or harmful situations on board are corrected right away.
 - The requirements for a first aid attendant are met, and first aid supplies are replaced as soon as possible after they are used.
 - Labels and Material Safety Data Sheets (MSDSs) for any controlled products are kept on board and are accessible to the crew. See the “Safety Procedures” section for information on Workplace Hazardous Materials Information Systems (WHMIS), which includes labels and MSDSs.
- Effective procedures are in place for communicating between the bridge and all work areas on the vessel.

Crew

It’s up to the crew to perform their work safely at all times. In particular, the crew **must**:

- Carry out work according to established safe work practices
- Take all reasonable steps that are necessary to protect their own health and safety and that of others on the vessel
- Report unsafe or harmful conditions or situations to the master right away
- Properly use all required protective equipment (e.g., personal flotation devices, immersion suits, hearing protection) and keep such equipment in good condition
- Report all injuries to the master right away



Safe at Sea



Emergency preparedness and procedures

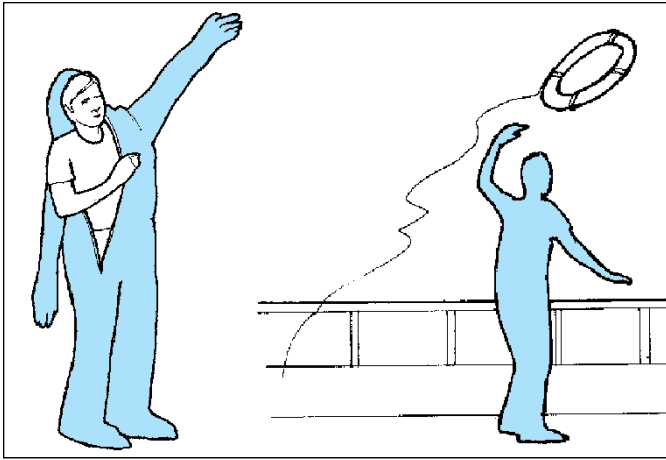

Emergency drills

Emergencies often happen in rough seas, in an unstable vessel, or in darkness. Crew members **should** have enough practice that they can perform these procedures in emergency conditions.

The master **must** establish the written emergency procedures and assign responsibilities to crew members so the crew is prepared in the event of an incident. The muster list **should** be posted prominently, and crew members **should** be made aware of their duties.

There are five types of drills dealing with five types of emergencies that a master **must** conduct at the start of the fishing season, whenever there is a crew change, and at intervals to ensure that crew members are familiar with emergency procedures. Everyone **must** be trained in the location and use of safety equipment.

Drills **must** deal with the following five types of emergencies:

- **Flooding of the vessel**
A flood drill might include knowing the vessel's pumping capabilities and how to remove water from a compartment, freeing the scuppers, and checking for items that could be stowed or if necessary removed from the vessel.
- **Fire on board**
Fires most typically start in the galley or engine room. In a drill, make sure crew members know their escape routes and the location and use of firefighting equipment, as well as how to alert the master and crew members of a fire. Also ensure the crew understand the different firefighting techniques for the different fire types (e.g., electrical, oil, wood).
- **Crew member overboard**
A person in the water needs to be rescued as quickly as possible before cold water immersion results in death. A crew member falling overboard is a serious situation. In the frigid waters of the Pacific, a crew member can die in a matter of minutes as a result of cold water immersion. That's why the master of a fishing vessel **must** put in place procedures for recovering an overboard crew member and **must** ensure that the crew practises these procedures. See "Cold water survival" later in this section for the types of procedures to include in your crew overboard drills.
- **Abandoning ship**
If crew members need to abandon the vessel, they need to know how to sound the alarm: at the direction of the master, meet at the muster stations, put on immersion suits, and release life rafts. The drill **should** use the equipment to the extent practicable and without damaging it or creating a hazard.
- **Calling for help**
Every crew member **should** know how to call for help. Methods can include VHF radios (including digital selective calling [DSC] or single side band [SSB]) radios, cell phone,

satellite phone, flares, and distress flag. If there is an emergency position indicating radio beacon (EPIRB) on the vessel, crew members **should** know how to activate it.

Once a drill has been completed, record the date, location, and type of drill in the log book.

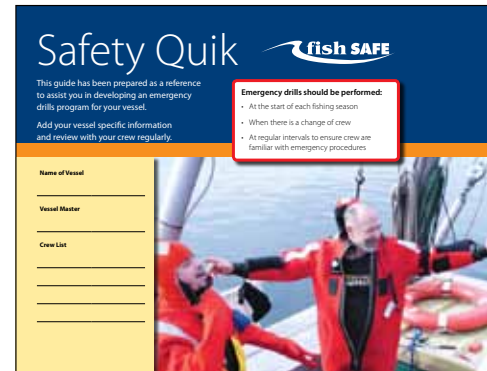

Fish SAFE has developed *Safety Quik*—a guide prepared as a reference to assist you to develop an emergency drills program for your vessel. It includes space to add your vessel's specific information, and it's a great tool to use to regularly review emergency drills with your crew. For more information or to obtain a copy for your vessel, contact Fish SAFE:

Phone: 604 261-9700

Email: gina@fishsafebc.com

Website: www.fishsafebc.com

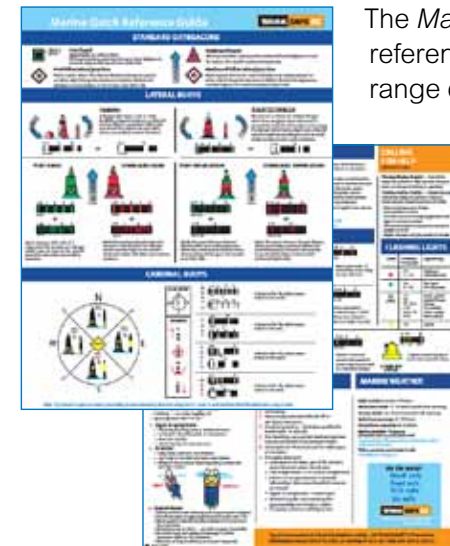

The *Marine Quick Reference Guide* produced by WorkSafeBC is an excellent quick reference sheet to have on board. It contains at-a-glance information about a range of safety topics, including:

- How to read and interpret common beacons and buoys
- Marine radio emergency procedures
- Hypothermia
- CPR
- Weather

Contact WorkSafeBC to obtain copies of this resource, or access it online at www.worksafebc.com/publications/health_and_safety/by_topic/assets/pdf/marinereferenceguide.pdf

Cold water survival

The cold waters off the B.C. coast pose danger to those who work on them. Being prepared increases the chance of survival.

Investigations show that the chance of surviving cold water without a personal flotation device is significantly reduced. Here are some safety tips to lessen the effects of cold water immersion:

- Wear an immersion suit or personal flotation device.
- If in the water, keep as much of your body afloat as possible.
- Have a means of getting back on board as soon as possible. This point **must not** be overlooked.

Suitable equipment for recovering an overboard crew member—for example, a life ring or a sling—**must** be kept on board.

Develop and practise rescue procedures—The master **must** ensure that suitable equipment is on board and that the crew regularly practise emergency procedures to rescue a crew member overboard. All crew members **should** know how to:

- Get back on board quickly if they fall in the water
- Recover someone quickly who has fallen overboard
- Perform first aid safely on someone who may be suffering from near-drowning or hypothermia

The following are examples of typical procedures for a crew member overboard situation:

- Have one person keep sight of the person in the water at all times.
- Throw a life jacket, life ring, or a brightly coloured floating object into the water to help the person, and to help you return to the spot where the crew member fell in.

- Tell the wheelhouse what's happened (for example, from which side of the vessel the crew member fell). Have someone continue to verbally direct the vessel operator to the overboard crew member.
- Carefully manoeuvre the vessel to pick the person up (e.g., the Williamson Turn). When pulling in the overboard crew member, be careful not to get pulled in the water yourself.

Understanding the effects of cold water will assist crews to prepare for cold water immersion. A person can pass through four distinct physiological stages when exposed to cold water, and any one of the following stages can be fatal:

1. **Initial immersion, or cold shock.** Symptoms include a significant increase in heart rate and blood pressure and difficulty breathing. Stage 1 typically results from a sudden and unexpected immersion and can lead to drowning in a few minutes.
2. **Short-term immersion, or swimming failure.** Symptoms include a loss of body heat, shutdown of extremities, and loss of coordination. Stage 2 typically occurs following increased effort in the water, which exposes more surface area and increased cooling. This can lead to drowning in 3 to 30 minutes.
3. **Long-term immersion, or hypothermia.** Symptoms include the body core cooling and semi-consciousness. Stage 3 can lead to heart failure or drowning as the cooling body temperature causes the person to lose the will to fight, thereby becoming more susceptible to ingesting water.
4. **Post-rescue collapse.** Symptoms include excessive drop in blood pressure. Stage 4 can lead to brain or heart failure even many hours after exiting the water.

The Williamson Turn

A common manoeuvre used to retrieve a crew member overboard is the Williamson Turn. The following steps are especially useful at night or when visibility is poor, such as in fog or heavy rain:

1. Pull the rudder hard over to the side from which the person fell overboard.
2. Keep the rudder held hard over, and maintain engine speed until the vessel is about 60 degrees from the original heading.
3. Ease the rudder and pull it hard over to about 210 degrees in the opposite direction.
4. Bring the vessel upwind of the person. Put the engine in neutral. Let the vessel drift dead ahead to the crew member. Position the vessel so that the person is alongside, well forward of the propellers.

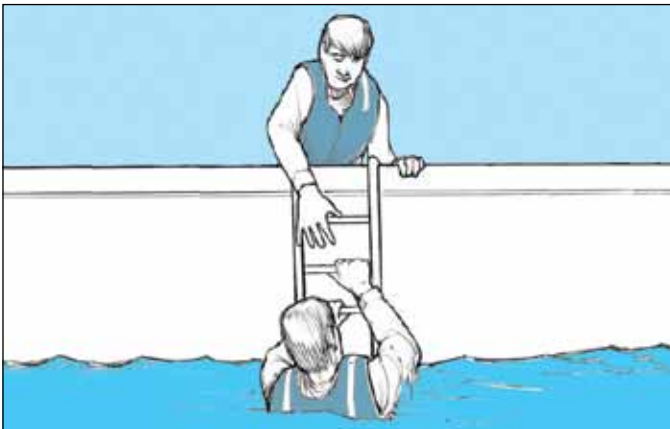
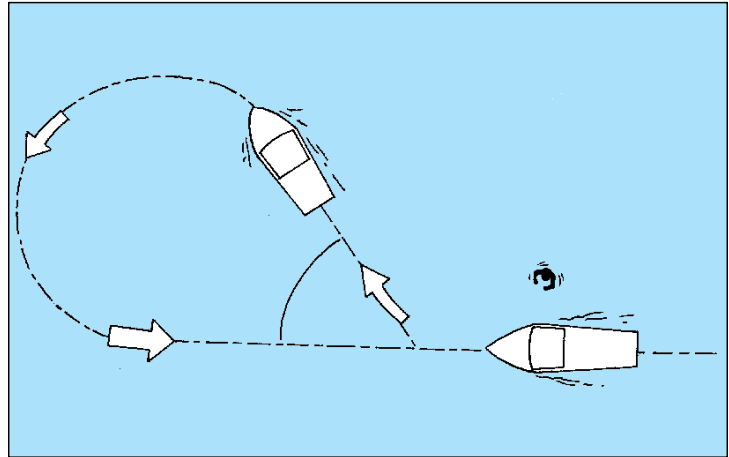

Have a means for getting back on board the vessel, such as a ladder or tires.

Abandoning ship safely

If you need to abandon ship, avoid entering the water if at all possible. If you do fall in, try not to panic, and keep as much of your body out of the water as possible.

Develop procedures that allow crew members to go directly into life rafts to avoid getting wet. Make sure to put on immersion suits, personal flotation devices, or life jackets.

The effects of sudden, unexpected cold water immersion are deadly. Be prepared!



Fish SAFE has developed a *Safe at Sea Procedures Guide* to assist fishermen in creating procedures specific to their vessels. The guide includes templates and examples you can modify.

The guide is part of the "Safest Catch" program. Contact Fish SAFE for more information at 604 261-9700 or online at www.fishsafebc.com

Vessel stability

The owner of every fishing vessel **must** have vessel documentation on board that is readily accessible to crew members and describes vessel characteristics, including stability.

Prior to sailing

Before leaving port, your vessel **must** be ready and capable to travel. Consider the following:

- The vessel **must** be seaworthy. The vessel **must** be watertight and equipment **must** be secured. Vessel stability is improved if fuel and water tanks are full, the boom is down, and weights (such as nets) are kept low.
- All cargo, fuel containers, other supplies, and the skiff—if your vessel has one—**must** be safely stored and secured.
- The vessel **must** be safely ballasted.
- Consideration **must** be given to current and forecast weather conditions.

See Appendix B for a checklist you can use or adapt to identify concerns with your vessel's systems, equipment, and supplies.

Threats to stability

Modifications (additions, change fishery/gear type)

- Typical modifications may include a larger drum, heavier net, a raised drum for more deck clearance, a larger winch, extended stern ramp, holds converted from dry to wet stowage, outfitting weights added high on the mast or superstructure, a shift from dead skiff to power skiff, a new platform on deck for traps, a full load of traps on deck, and the addition of live tanks.
- Record modifications to the vessel on the form found at www.tc.gc.ca/eng/marinesafety/bulletins-2008-01-eng.htm.

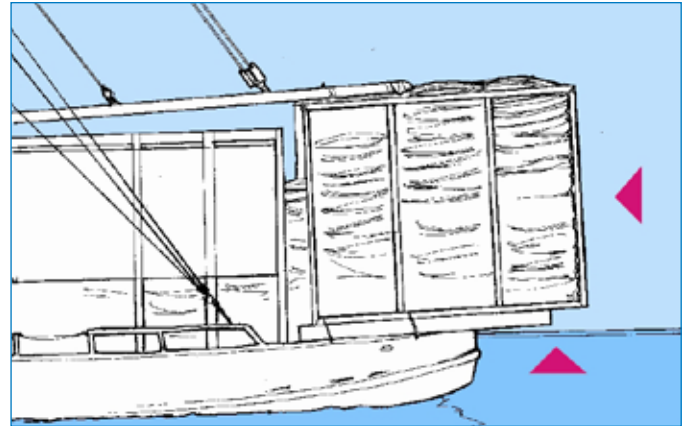

- Have major modifications to the vessel — such as trap extensions, wheelhouse alterations, and tank redesigns — thoroughly checked. Such modifications must be verified by a knowledgeable professional such as a naval architect.

Weight creep

- When carrying unnecessary spare parts
- From time to time, take an inventory and remove what is not needed on board

Extreme trim

- When weight is loaded at the stern or bow

Added weight

- When drying up, travelling with skiffs and net on the drum or with punts on board
- When towing skiffs and net

Reduced freeboard

- Due to loading, extra gear on board, and vessel modifications

Slack tanks and free surface effect

- Keep scuppers and freeing ports clear to allow water to quickly drain from the deck.

- Manage tanks to minimize free surface and its impact on stability. Be aware that packing fish wet compared to packing dry increases the total cargo weight by almost 30 percent. You may need to reduce your fish tank's volume accordingly to ensure adequate freeboard and stability.
- Avoid slack fish tanks whenever possible. Especially when in transit or when loading over the side, fish tanks should be either fully pressed or completely empty.

Watertight integrity

Water entering the hull decreases freeboard and increases free surface effect. Potential down-flooding points include doors, hatches, scuttles, and portholes.

- Make someone responsible for checking doors, windows, and hatch closures regularly to ensure that the seals are still effective.
- Stress the importance of keeping openings securely closed when underway, except when being used.
- **Single crossbar-type hatch covers**
Assessment by the Transportation Safety Board of the design, operation, maintenance, and seating of the hatch covers indicated the hatches are susceptible to failure. This results in leakage and, in extreme cases, down-flooding, which leads to the loss of stability and the loss of the vessel. Owners of vessels fitted with this type of hatch are strongly encouraged to:
 - Inspect the hatches for material defects
 - Contact the manufacturer for any operation and maintenance instructions, and conduct the recommended maintenance

- Ensure that the hatches will maintain watertight integrity under all conditions of operation
- Demonstrate to all crew members the correct operation of the hatches and point out potential problems with their operation and maintenance

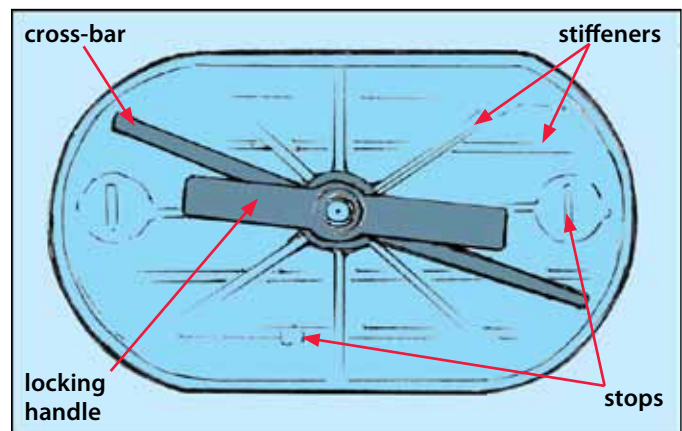

View of the underside of a single crossbar-type hatch cover.

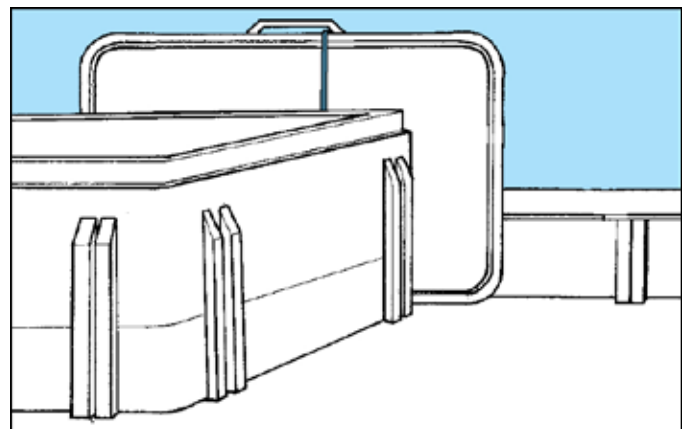

After removing hatch covers, secure them so they won't slide or shift.

Other strategies for maintaining vessel stability include the following:

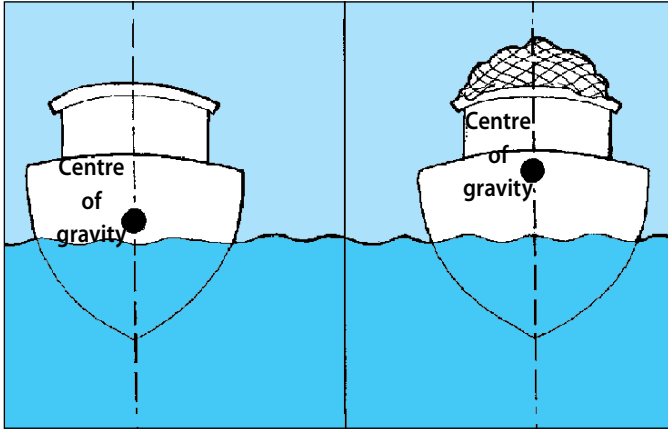

- Keep weight in the vessel as low as possible. This makes the vessel more stable and less likely to capsize. Make sure the vessel is not overloaded because overloading can cause the vessel to be unstable.

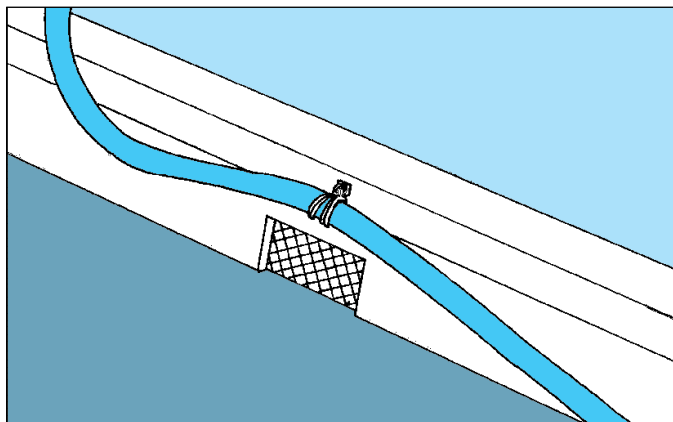

- Make sure scuppers are not blocked by equipment, tools, hoses, lines, or debris. Blocked scuppers can pose a serious hazard, especially in rough seas.

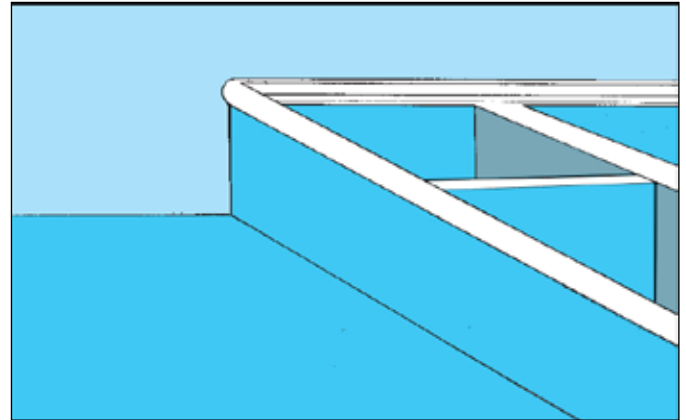

- Be aware of open tanks. Cover tanks after delivering or unloading fish. Secure them in heavy weather to keep water from sloshing out of the tanks. Water loss from the tanks can lead to free surface effect and related stability problems.

**Fish Harvesting Alert:
Vessels Capsizing and Lives Lost**

How stable is your vessel when you modify it for the same fishery?

<p>All Equipment Secure The vessel must be secured to prevent any equipment from shifting or falling overboard. The vessel must be secured to prevent any equipment from shifting or falling overboard.</p>	<p>Even Keel • Check for trim quality • Adjust trim as needed</p>	<p>Reduce Freeboard • Reduce freeboard • Reduce deck height • Reduce deck load • Reduce deck height • Reduce deck load</p>
<p>Weight of Safety The vessel must be secured to prevent any equipment from shifting or falling overboard. The vessel must be secured to prevent any equipment from shifting or falling overboard.</p>	<p>Stow Water Inside Tanks • Stow water inside tanks • Stow water inside tanks • Stow water inside tanks</p>	<p>Stow Deck • Stow deck • Stow deck • Stow deck</p>

WorkSafe BC

Instruct all crew members in vessel characteristics — including stability.

For more information about vessel stability, refer to the WorkSafeBC pamphlet, *Fish Harvesting Alert: Vessels Capsizing and Lives Lost*, available online at www2.worksafebc.com/i/posters/2005/fishing_stability_2005.htm.

Fatigue

Fatigue is a fact of life in the fishing industry. The effects of fatigue on work performance can put the vessel and crew at risk. WorkSafeBC classifies fatigue as “impairment,” like alcohol or drugs, as the effects can be just as devastating.

What do you know about fatigue?

Answer true or false to the following statements:

1. You can stockpile sleep when you aren't working.
2. Young people need more sleep.
3. I can tell when I am going to go to sleep.
4. I'm good on the wheel so it doesn't matter if I am sleepy.
5. Coffee overcomes the effects of drowsiness.

Check your answers below.

Watch for the following top 10 signs and symptoms of fatigue:

- Being more irritable than usual
- Being uncommunicative
- Being frustrated by tasks
- Being unable to stay focused

- Cutting corners to get the job done
- Losing the “big picture”
- Taking unusual risks
- Responding slowly to situations
- Not noticing risks or warning signs
- Doing tasks in the wrong order

The crew **should** talk about what fatigue looks like and be alert for the signs and symptoms. Individuals are poor judges of their own state of alertness. In assessing your own alertness or that of a crew member, do not make judgments based on how you or they feel at the time. Instead, assess the sleep patterns over the last few days.

Vessel procedures for managing fatigue can include the following:

- If you are falling asleep at the wheel, it is all right to wake someone else up.
- Use watch alarms and a buddy system when traveling at night.
- Have two crew members on the wheel at night.

When it's your wheel turn, give yourself at least 15 minutes of “wake up” time—talk with the person you are relieving and become fully aware of the situation you are taking over.

Answers

1. **False.** Sleep is not money, you can't save it up ahead of time, and you can't borrow it. Just as with money you can go into debt.
2. **True.** Young people need more sleep than adults. Males under 25 are at the greatest risk of falling asleep.
3. **False.** Sleep is not voluntary. If you are drowsy, you can fall asleep and never even know it. You cannot tell how long you've been asleep.
4. **False.** No matter how good you are at what you do, you can become confused and use poor judgment or make poor decisions when you are sleepy.
5. **False.** Coffee can help you feel alert but only for a short period of time.

Safety Procedures



General health and safety requirements



Fish SAFE has developed a *Safe at Sea Procedures Guide* to assist fishermen in creating procedures specific to their vessels. The guide includes templates and examples you can modify.

The guide is part of the “Safest Catch” program. Contact Fish SAFE for more information at 604 261-9700 or online at www.fishsafebc.com.

Hazard identification

Hazards on board your vessel may expose the crew to a risk of injury or occupational disease. Hazards **must** be identified and steps taken to eliminate the hazard or if that is not possible, minimize the risk to the lowest level possible by using engineering controls (e.g., installing hold-to-run controls), administrative controls (e.g., safe work procedures), or a combination of the two. All hazards and safe work practices **must** be reviewed with crew members.

Risk assessment

Conduct a risk assessment of the hazards on board your vessel by evaluating the tasks involved in the work processes. Identify risk factors that could cause injury to the crew. Risk assessments help determine how likely the risk factors are to cause injury so that higher-risk tasks can be prioritized to control the risk(s). See Appendix C for information on conducting a risk assessment for your vessel.

Safety procedures

Procedures addressing the identified hazards **must** be developed. They **must** be readily available and communicated to the crew.

Crew training

Proper crew training is essential to keeping a safe vessel and preventing accidents and injuries. Before the start of each fishing season, the master **must** instruct each crew member in the operational characteristics of the vessel. These include:

- The location and use of safety equipment such as life jackets, immersion suits, and life rafts.
- The location and use of emergency equipment such as fire extinguishers and emergency beacons.
- The location and use of engine room components and controls. For example, the crew **should** know how to properly use the bilge blower (if one is installed in the vessel), how to correctly read gauges, and how to safely take on fuel.
- The use of deck equipment and rigging such as davits, winches, and master on/off switches.
- The use of navigation equipment and electronic aids. For example, the crew **should** know how to use equipment such as depth sounders, watch alarms, radar, and the automatic pilot.
- Safe work procedures for use of fishing equipment for each type of fishery the vessel will be engaged in. For example, on packers and other vessels carrying fish or cargo, procedures **must** be put in place for safely loading and unloading fish and cargo (such as stay clear of the brailer when it’s being lifted; wear appropriate protective equipment such as boots, hard hats, and gloves, when necessary; secure the pump hose when pumping so it doesn’t swing around).
- Procedures for anchoring. For example, the crew **should** know how to safely operate the anchor winch, how to secure the anchor, and how to operate the hydraulic or electric anchor controls.
- Escape routes in the event of fire, including from the engine room and crew quarters.

The master **must** make sure that all crew members can apply the training information to protect their health and safety. All new crew members **must** be given the required training prior to sailing. Training may vary for individual crew members depending on the tasks each is assigned to do.

Training your crew is effective when well thought out beforehand. Here are some training tips to consider:

- Be clear about the knowledge and skills you want the crew to have as a result of the training.
- Communicate the information effectively. Use more than one training method to reach as many learning types as possible—tell them, show them, and ask the crew to demonstrate the desired skill.
- Involve the crew—explain, ask questions, listen, provide positive feedback, and acknowledge good performance.
- Train by example—model safe work practices at all times.
- Document the training that took place.

Safety talks with crew

Conduct safety talks regularly. Consider these guidelines to help you prepare:

- Choose a safety topic relevant to the work the crew is doing.
- Be prepared by inspecting the vessel for hazards related to your topic.
- Get the crew actively involved in the meeting. Choose a real life example to talk about, and invite the crew to ask questions and make suggestions related to the topic.
- Invite crew members to come to you any time with safety problems and suggestions about topics for future safety talks.

Show that you take safety seriously by setting an excellent safety example for others.

Regular inspections

Document regular inspections of work procedures, equipment, and machinery. Inspections are required to ensure hazards are eliminated and controlled. Any unsafe conditions found during a regular inspection **must** be reported immediately to the master or owner and remedied without delay.

Maintenance

Equipment **must** be used and maintained according to manufacturer's instructions and safe work practices.

Housekeeping

All work areas **must** be maintained in a state of good repair and kept free of slipping and tripping hazards. Garbage, spills, and other waste material **must not** be allowed to accumulate.

Records

Maintain a first aid treatment record book, inspection and accident investigation reports, and records of training. These allow you to identify trends of unsafe conditions or work procedures with a view to developing good preventative measures.

Incident and accident investigations

Investigate all incidents and accidents, even "near misses" that did not result in injury or disease. This will help you identify the cause(s) and steps to prevent similar unsafe conditions.

Report serious incidents

Masters or owners **must** immediately notify WorkSafeBC of any serious incident, injury, or fatality. Information about reporting accidents to WorkSafeBC and conducting investigations is in the "Claims, Investigations, and Insurance" section.

Safety for all vessels and crew

General safety

Keeping a general state of safety on your vessel means thinking ahead, staying alert, and being organized. For example, put equipment and tools in their places. Keep your vessel log up-to-date—it's a good place to keep track of equipment maintenance. Also use the log to record the results of the pre-sailing check of your vessel's systems, operations, and equipment.

Other general safety procedures and requirements include the following:

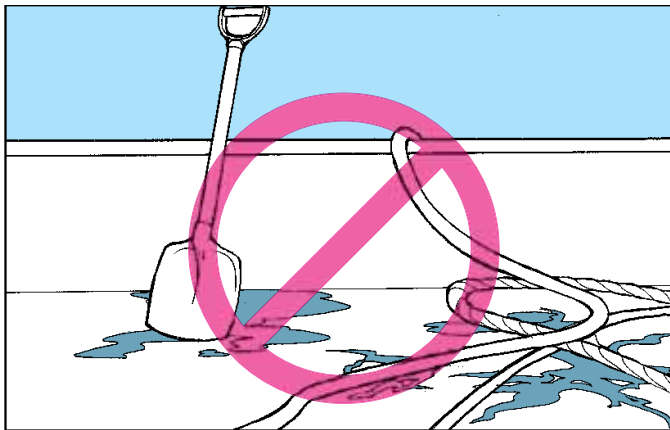

- All work areas—including decks, the engine room, the wheelhouse, and the anchor area—**must** be kept free of slipping and tripping hazards.

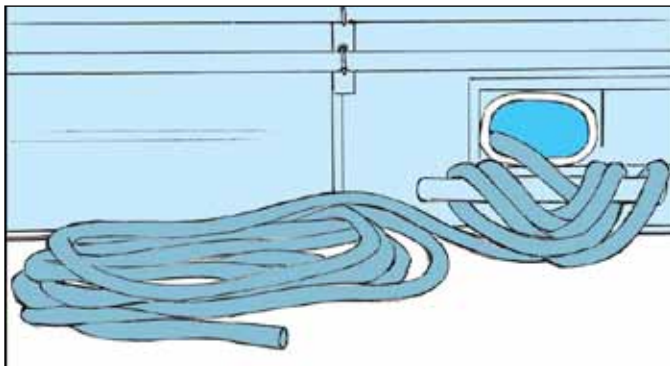

- Coil and stow tie-up lines at all times.

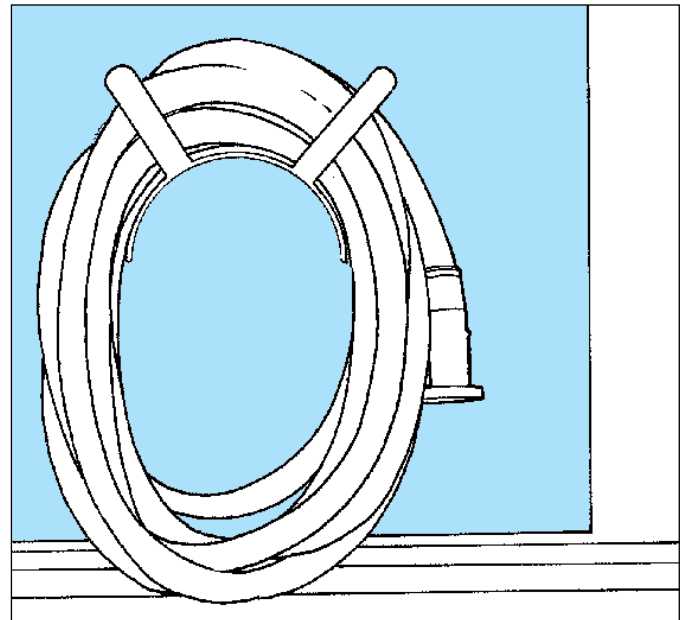

- When not using water hoses, coil them on brackets.

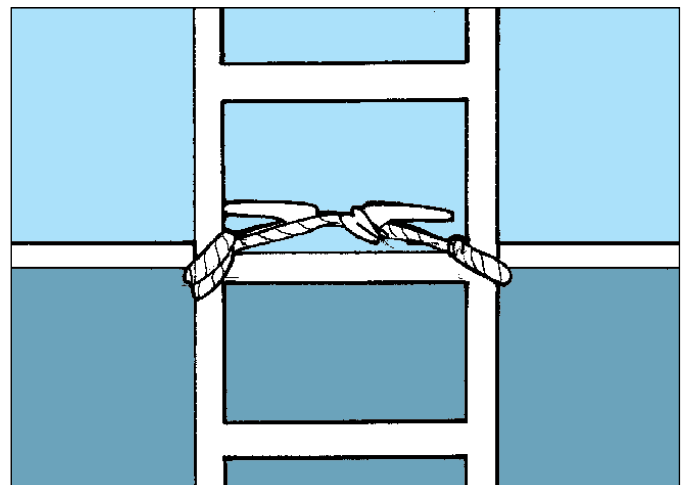

- Ladders **must** be of sound design and in good condition. When using portable ladders, they **must** be secured.

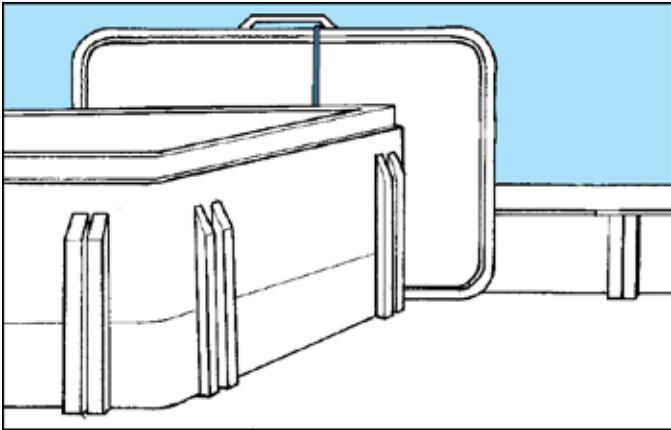

- After removing hatch covers, secure them so they won't slide or shift.

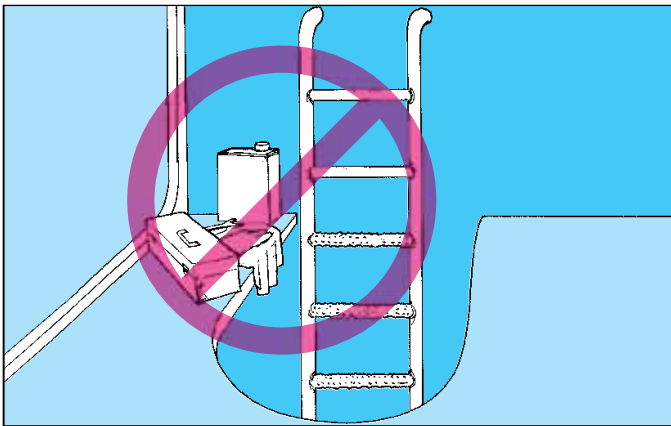

- Keep passageways clear. Don't store gear in them.

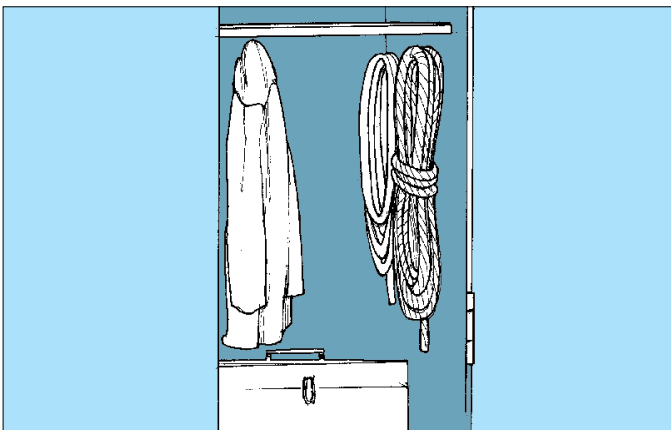

- Tools and equipment **must** be securely stowed when not in use. For example, properly store

gear such as web, hand tools, ropes, and poles. Store gaffs safely, with the hook down or the point covered.

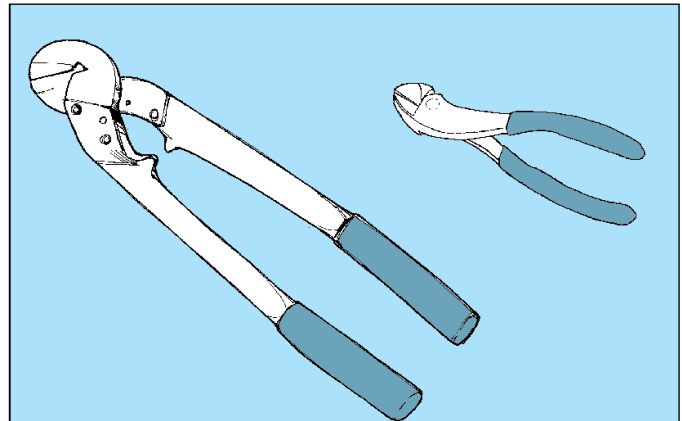

- Keep a bolt cutter, wire cutter, and axes on board to cut lines or gear that is tangled or needs to be cut away quickly.
- Always wear a life jacket or personal flotation device and carry a sharp knife.
- Wear sunscreen:
 - In summer, even on overcast days
 - In direct sunlight year-round. Exposure to direct sunlight at any time of the year can cause skin cancer.

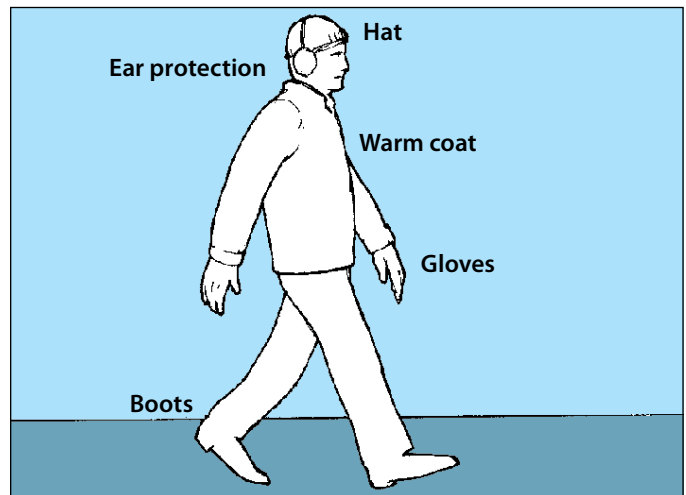

- When working in freezers, you **must** wear warm clothing that includes a hat, boots, and gloves.



- Keep your hair (both on your head and on your face) short enough or tied back so it won't get snagged in a pulley, winch, capstan, or other equipment.

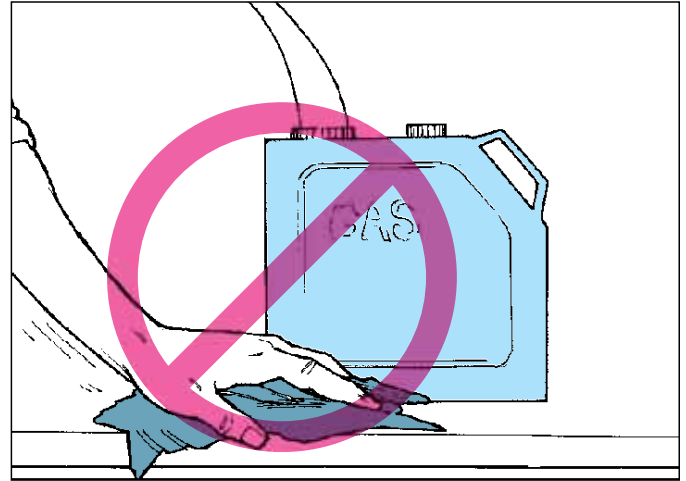

- Don't clean with gasoline or other solvents that can catch fire.

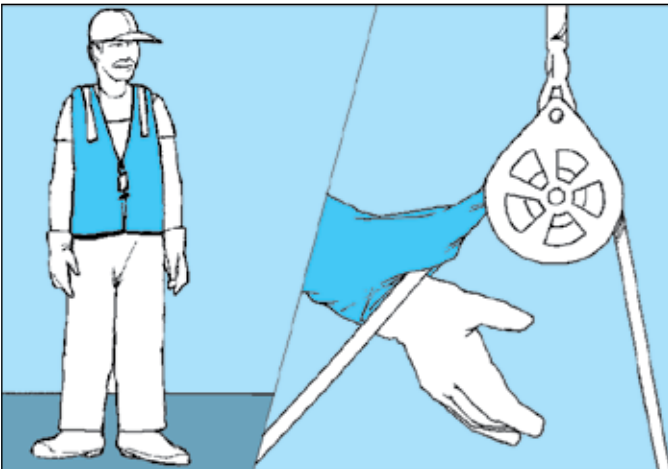

- Wear close-fitting clothing, which is less likely to get caught in nets, lines, or machinery. Avoid wearing clothing with exposed buttons, or cover them with tape to reduce the risk of getting caught in nets and other gear.

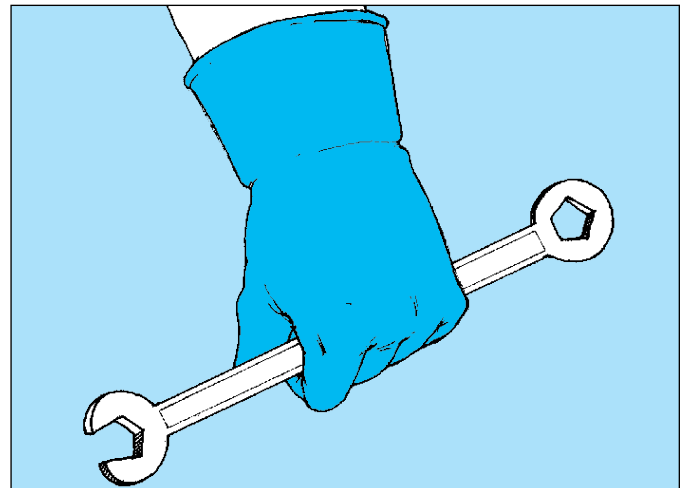

- Don't adjust, oil, or clean equipment while it is operating unless safe work procedures are in place that will protect you from injury.

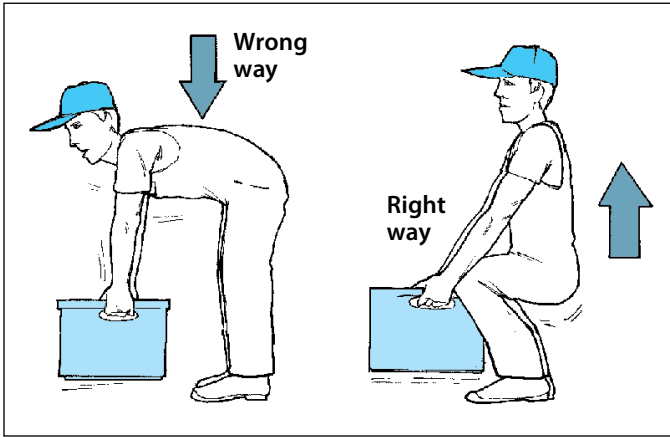

- All crew **must** be taught safe lifting techniques. Bend your knees and lift with your legs, not your back. Keep the weight close to your body. Use a hoist or winch, or ask for help if something is too heavy to lift by yourself. Don't take chances – back injuries can end your career.

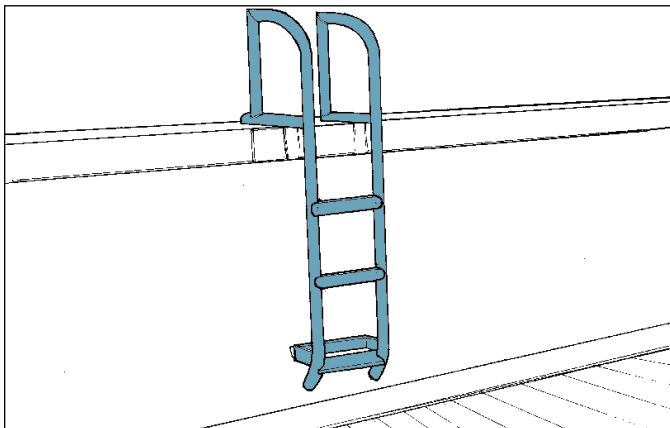

- Use a gangway or ladder to board or exit the vessel. Gangways and ladders used for boarding or exiting **must** be secured. When possible, use a ladder or gangway that hooks over the bulwark. Keep gangways and ladders clean. Ice, oil, and slime can make them slippery.

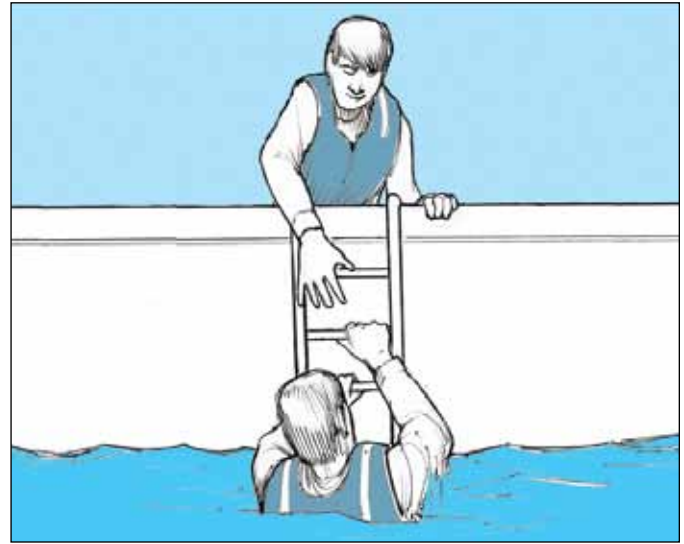

- Provide a means of getting back on board in case a crew member falls into the water.

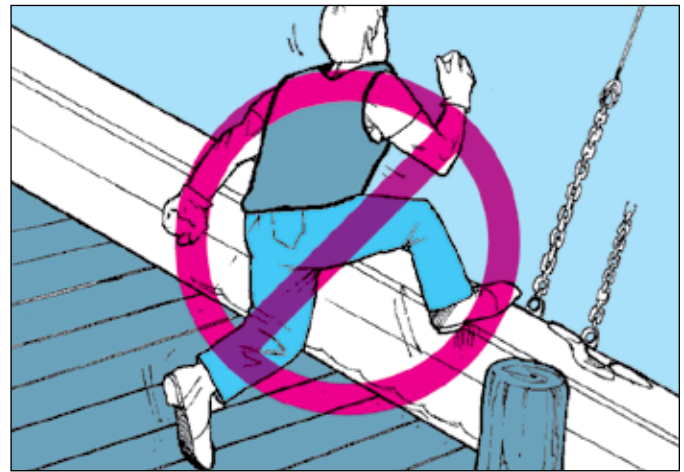

- Never run or jump from the dock to the vessel, or between vessels.

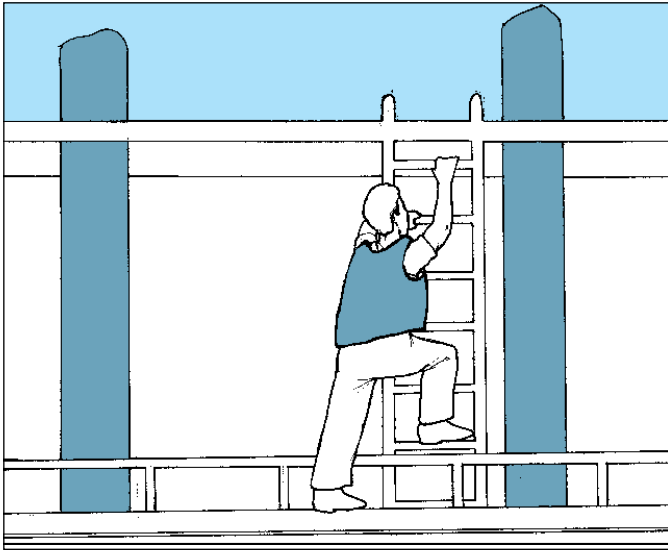

- If the vessel deck is lower than the dock, climb down the dock ladder to the deck or bulwarks. Then step over, holding a ladder rung with one hand and the vessel railing with the other hand. Maintain three-point contact to prevent injury.

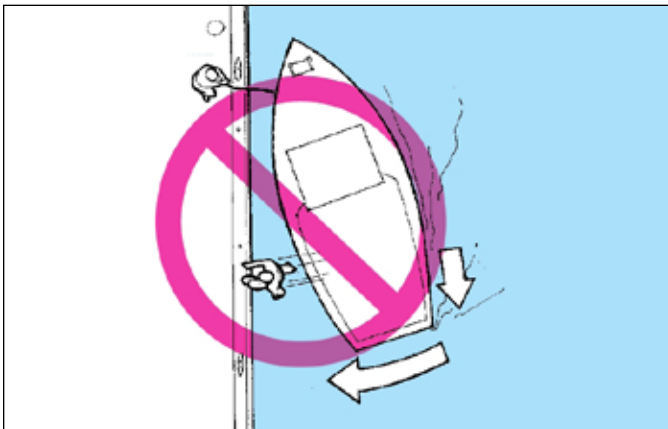

- When tying the vessel to the dock, don't exit the vessel until it is safe. If you exit too early, you're more likely to slip between the dock and the vessel.

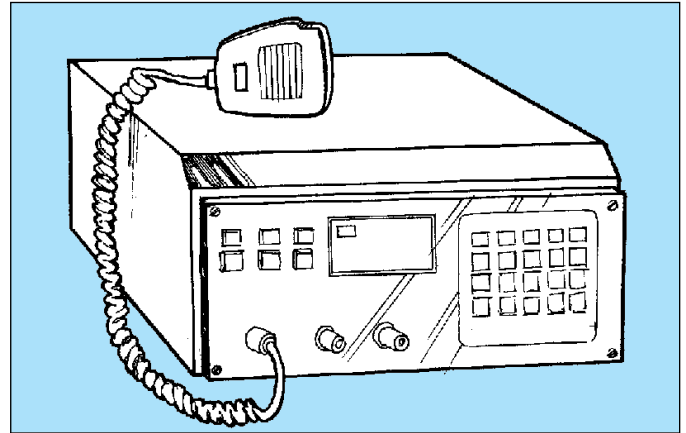

- All crew **should** know how to operate the vessel's radio. Monitor channel 16 (emergency) and your fishing channel. Also monitor vessel traffic (marine communications and traffic services [MCTS]) for updates on traffic and navigation hazards, the weather channel, and emergency calls. Know your maritime mobile service identity number (MMSI) and how the digital selective calling (DSC) system works.

Deck

Procedures and requirements for safety on vessel decks include the following:

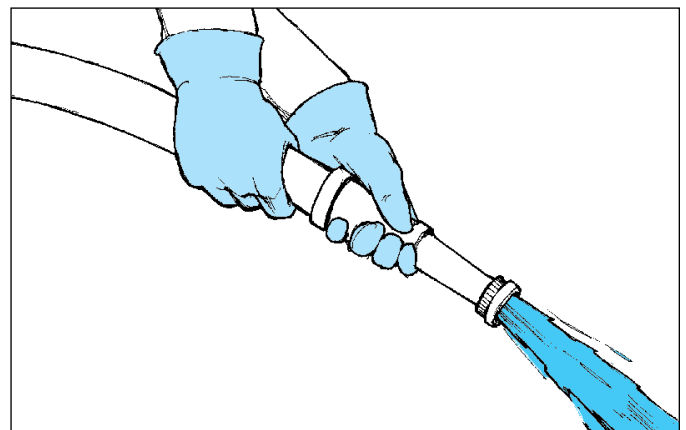

- Regularly hose down decks and other areas to remove fish slime. This will help reduce slips, trips, and falls.

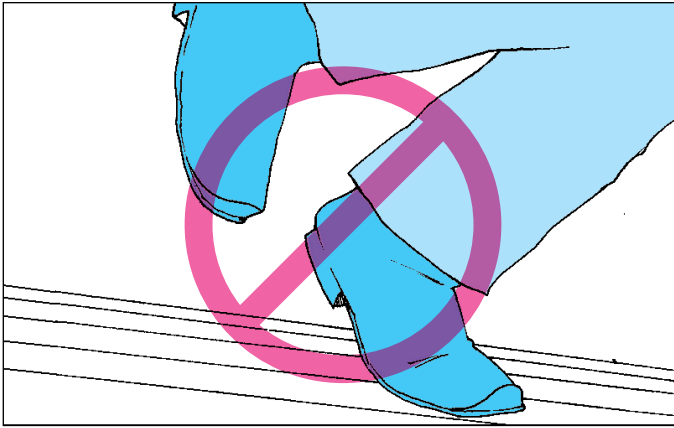

- Don't run on deck—you're more likely to slip, trip, or fall.

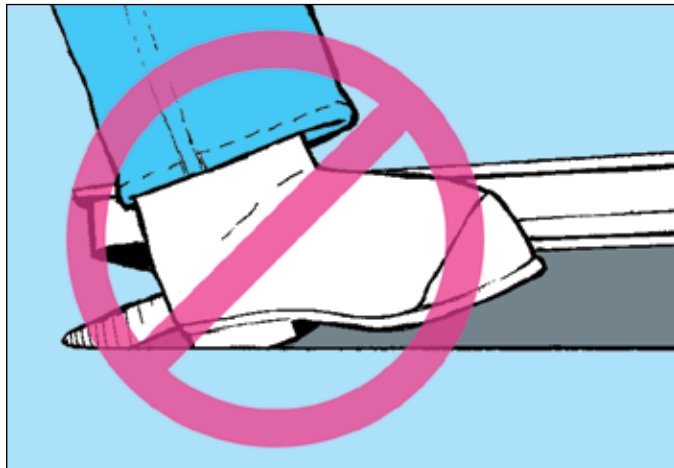

- Never walk on or over a partially open hatch or manhole. If the hatch or manhole cover shifts, you could fall down the opening.
- Deck openings and hatches that are not being used **must** be closed and secured to prevent down-flooding and keep crew members from accidentally falling into them. Make sure manhole covers seal properly.

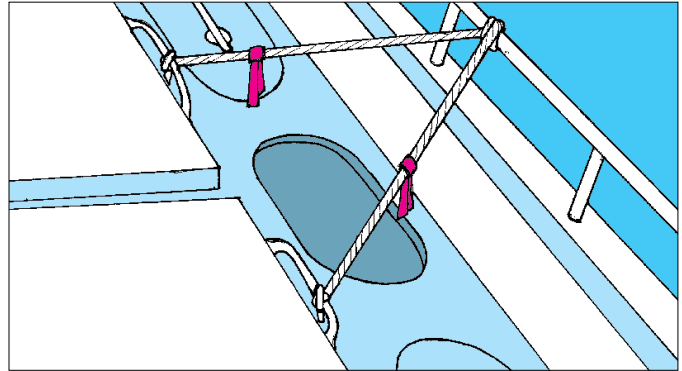

- Deck openings and hatches that need to be open for ventilation **must** be marked and guarded.

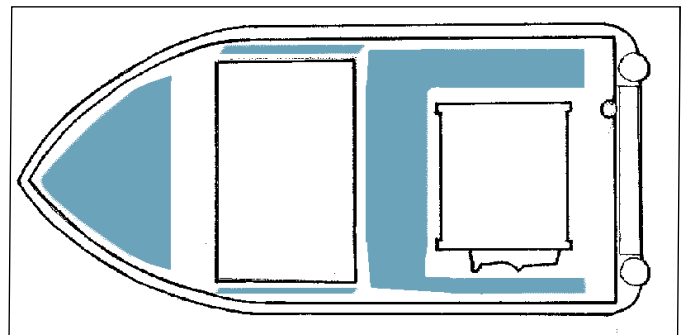

- Decks **must** have non-skid surfaces except where a smooth surface is needed for handling fish.

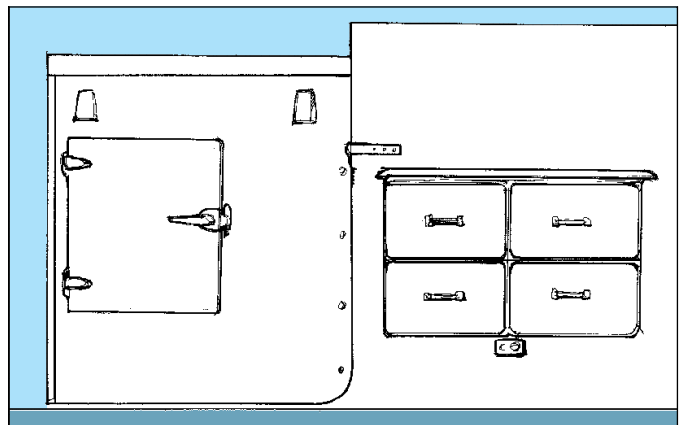

- Be aware of possible leaks of refrigerant gases such as freon. High levels of freon can suffocate workers. After inspecting refrigerant levels, shut off sight glass valves. This will reduce the loss of freon in case the sight glass breaks.

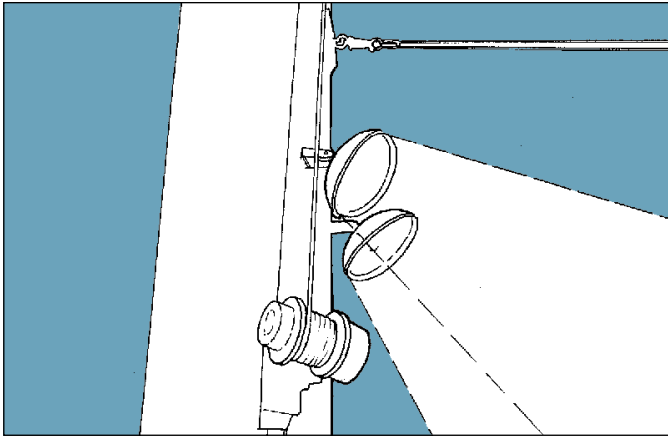

- All work areas **must** have enough lighting so work can be done safely. Make sure there is enough lighting in stairways, companion ways, and near ladders. Make sure deck lights do not interfere with the night navigation of other vessels. (As an added safety step, consider attaching a safety line to large floodlights—a light fixture that falls from its mounting could seriously injure crew members.)

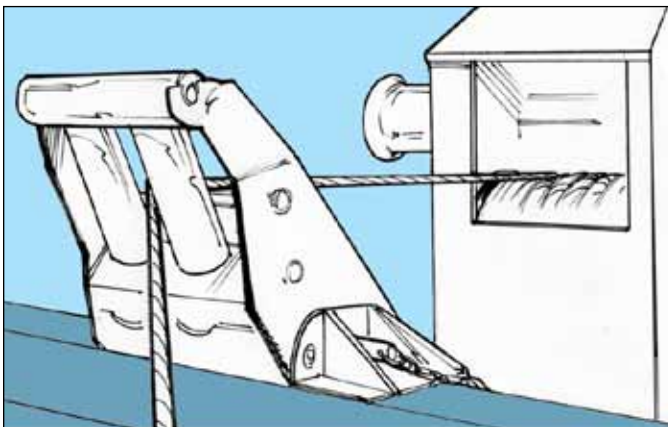

- All movable davits **must** have a device to lock them in place so the davit does not jerk back and strike crew members. Don't use a bolt in place of a locking pin.

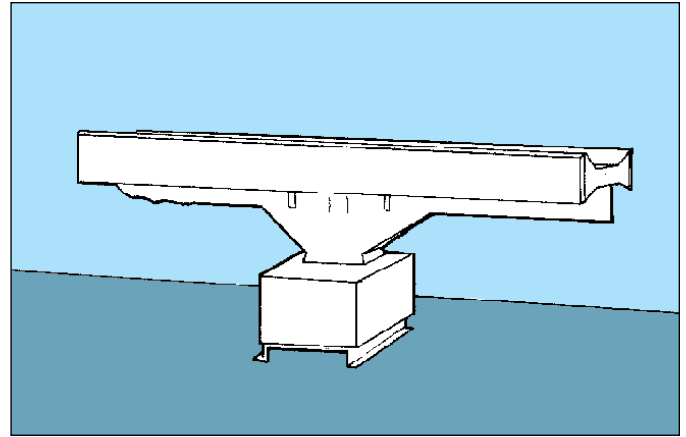

- Stay clear of the radar scanner. It can cause serious injuries when rotating. Put a "Do Not Operate Radar" sign on the wheelhouse radar when someone is working aloft.

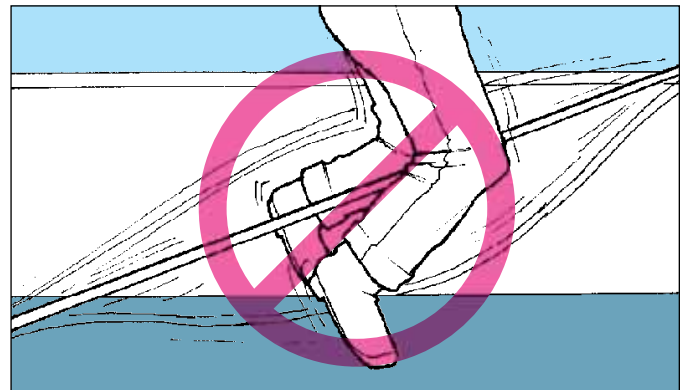

- If possible, avoid stepping over lines under tension. Sudden strains can cause them to bounce wildly up and down. Be aware of the hazard if you need to step over the lines.

Engine room

Fuel leaks can cause fires or explosions. Exhaust leaks can result in carbon monoxide buildup, which can asphyxiate the crew. Although unusual, these accidents do happen. Provide good ventilation in the engine room, and inspect equipment regularly. Keep records of filter changes and other scheduled maintenance.

Other safety procedures and requirements for the engine room include the following:

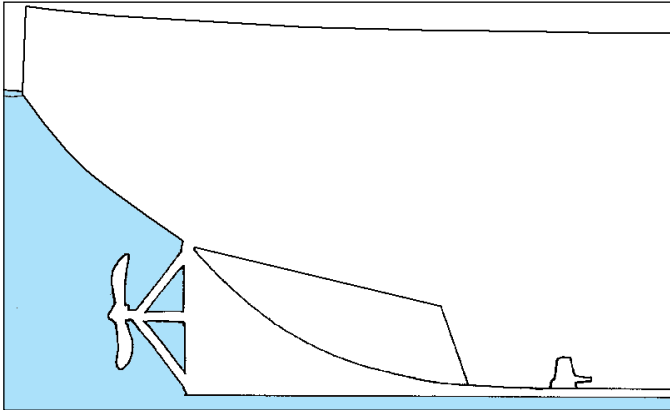

- Keep as little water in the bilge as possible. Clean the bilge strainers regularly and test the bilge alarm.

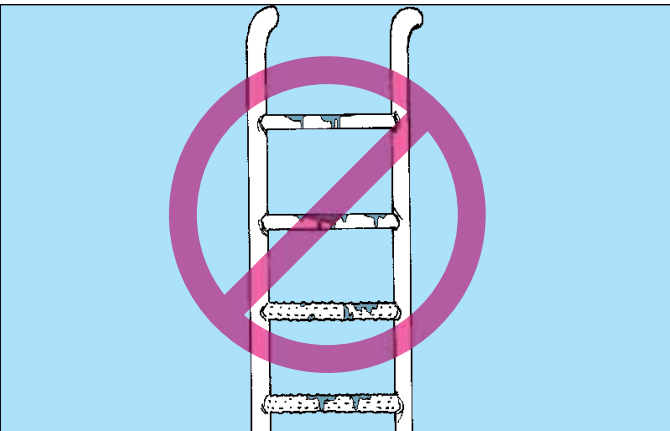

- Don't let oil and grease build up on engine room ladders or in the engine room itself. Clean ladders regularly to prevent crew from slipping and falling.

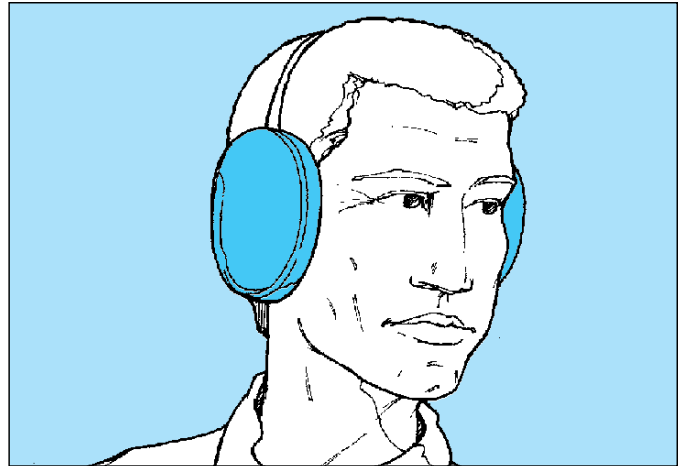

- Wear hearing protection when working in the engine room. Many people in the industry have damaged their hearing by not wearing ear muffs or ear plugs.

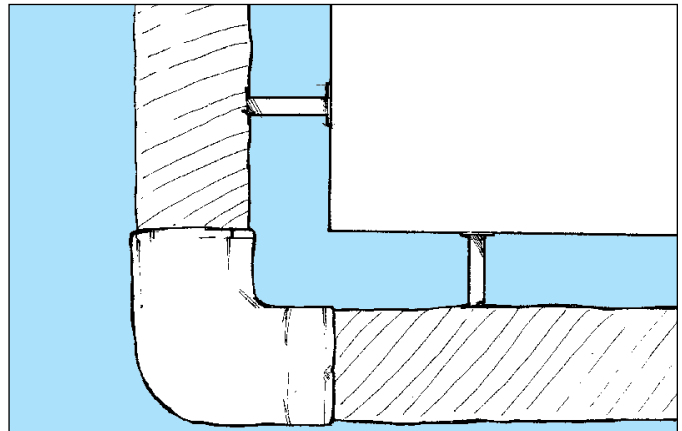

- Make sure all exhaust pipes are away from wood and other material that can catch fire. Cover the pipes with lagging where needed.

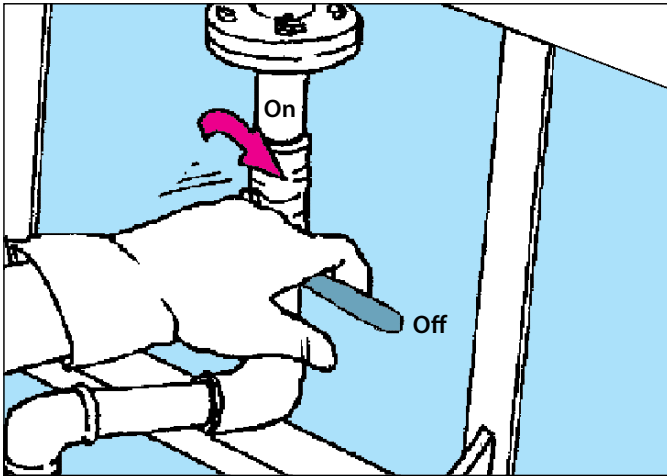

- When seacocks are not required to be open, turn the valve handle to the “off” position.

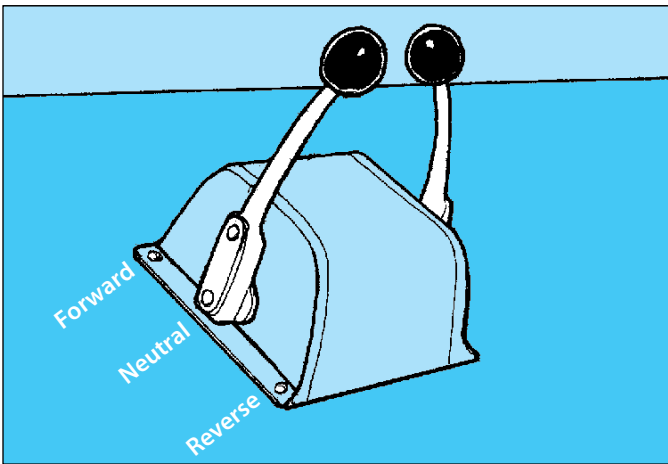

- Take the engine out of gear if you need to go out on deck when travelling alone or are alone on watch. That way, if you fall overboard, the vessel is less likely to travel away from you.

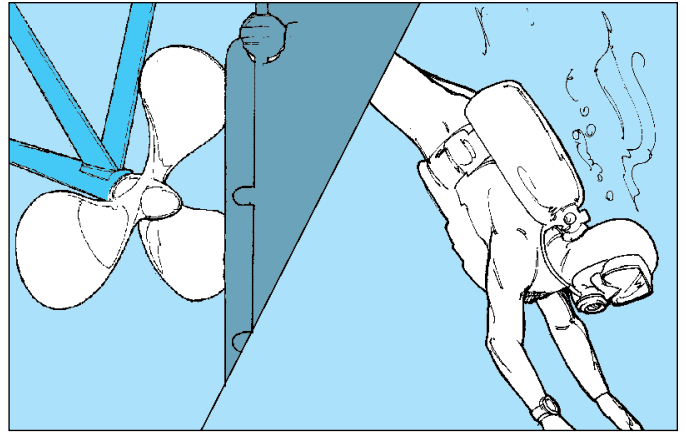

- The main engine **must** be turned off if a diver is working underwater near the vessel. Remove engine keys to ensure the engine is locked out. This prevents the diver getting caught in the propeller. Correct diving flags **must** be displayed when diving is taking place. (See the “Safety by Gear” tabbed section for more diving safety information.)

Fall protection

The following are recommendations and requirements for fall protection:

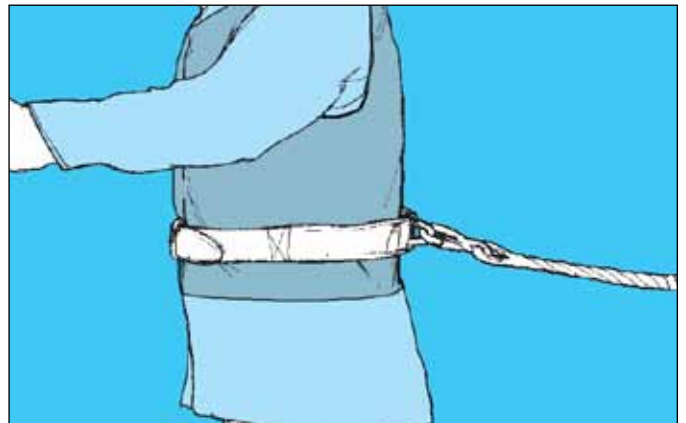

- When heavy weather or work conditions require it, crew **should** wear a safety line to protect themselves from falling overboard.

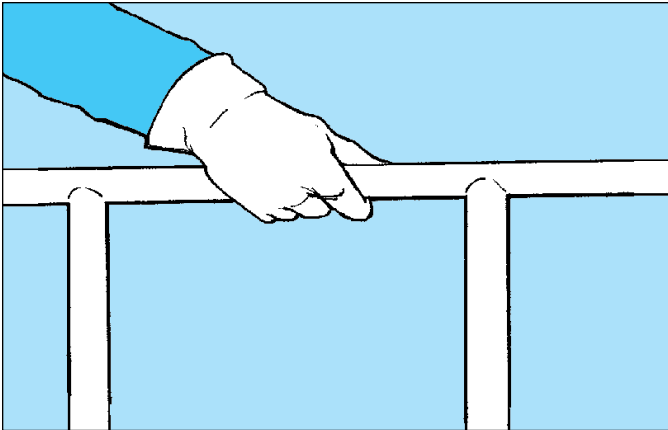

- Grabrails, handrails, or guardrails **must** be installed, where practical, to keep crew members from falling overboard.

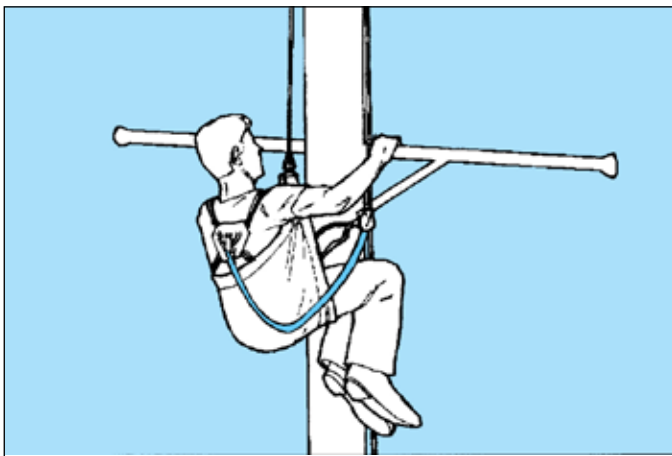

- When working aloft, wear a lifeline.

Fish handling operations

Many fish handling operations involve repetitive tasks that can cause injuries. Rotate crew among jobs to help reduce injuries caused by repetitive movements.

When inspecting fish handling operations on your vessel, consider the following ways to reduce injury to muscles, joints, and nerves:

- Make sure tables are the right height so crew members don't have to bend.

- Keep fish within easy reach so crew members don't have to overstretch.
- Work in front of the body to prevent twisting.
- Keep knives sharp to allow easy cutting.
- Change position or work tasks to avoid repetition.
- Keep hands warm by wearing gloves.
- Change tools or use a different knife to change the pressure points on your body.

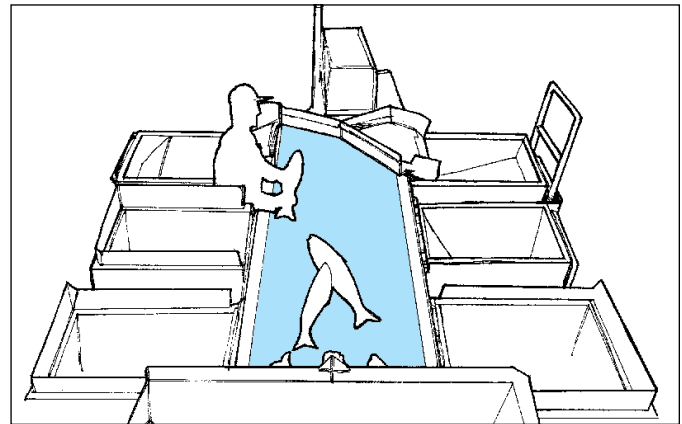

Other safety procedures for fish handling operations include the following:

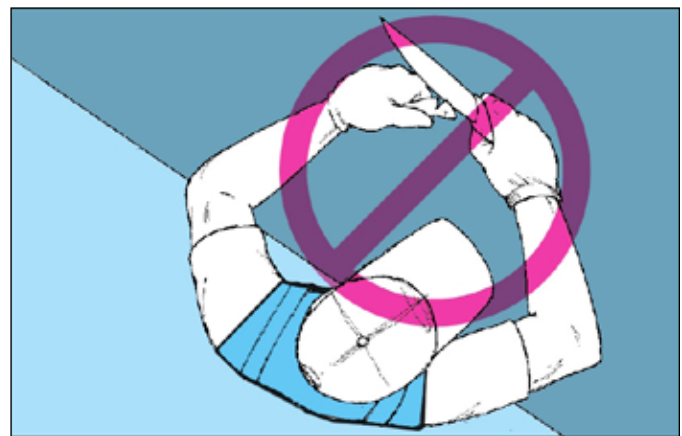

- Never cut bait toward yourself—always cut away from your body. Don't cut frozen bait.
- After dressing fish, properly store all knives and scrapers. Don't leave them lying on hatch covers or other places where crew members could be accidentally injured by them.

Fish spines: Avoid the dangers of toxins and bacteria in fish spines and slime

BC fishermen face life-threatening infection, tissue destruction, and loss of joint mobility—all from the sharp, toxic spines of dogfish, ratfish, rockfish, sea urchins, and others.

If a spine stabs you, start first aid right away. Do the following:

- Rinse the wound with soap and water
- Soak the wound in hot water (40–45°C) to relieve pain
- Continue soaking for 30 to 90 minutes, or longer if the pain continues
- Never apply a tourniquet or pressure to the wound
- Remove any visible spines

If the fragile spines break and leave fragments in tissue, don't try to dig them out. Keep the wound clean, and get medical attention as soon as possible. A doctor may use X-rays to find the fragments and then remove them.

Purple dye released by urchin spines may fool you into thinking spines are embedded under the skin. This dye is not toxic and will disappear in a few days.

Tell the doctor about your tetanus immunization history, and consider a booster shot.



When is it a medical emergency?

Radio for help immediately if:

- The injured person is in shock

Seek medical attention if:

- A spine punctures a joint space between bones
- Signs of infection appear—fever, redness or discoloration, warmth, swelling, pus, increasing pain, or altered sensation around the wound

For more information about avoiding the dangers of toxins and bacteria in fish spines and slime, consult the WorkSafeBC brochure, *Pure Poison: Fish Spine Injuries* online at www2.worksafefbc.com/PDFs/fishing/fish_spine_injuries.pdf.

Galley

Galleys are a prime spot for accidents. Hot stoves or spills of hot liquids can burn skin. Pots, pans, or knives can fall and hit the crew. Stove fuel leaks—or just plain carelessness—can cause fires. In fact, galley stoves are a leading source of boat fires. Use common sense to reduce galley hazards. Consider the following recommendations:

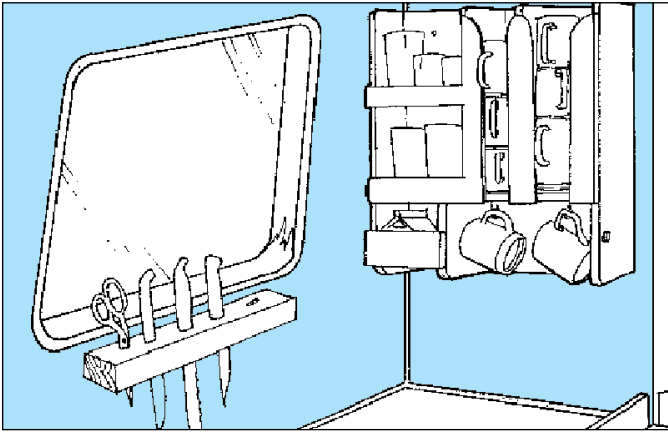

- Keep knives and other utensils stored safely in racks or drawers. Store pots and pans safely. Use table covers made of non-slip material.

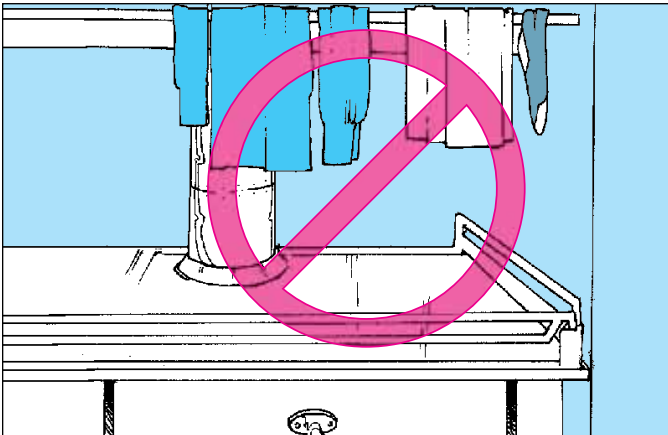

- Don't hang washcloths, gloves, hats, or other items over the stove to dry—they could fall onto the stovetop and catch fire.

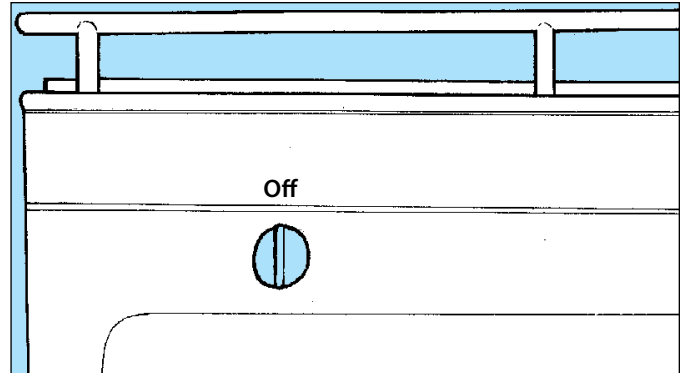

- Turn off all stoves and cabin heaters when leaving the vessel.

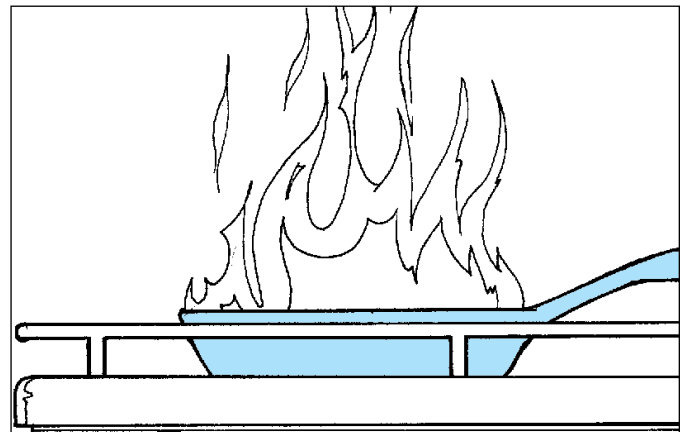

- Don't leave the stove unattended, particularly when cooking with grease or oil.

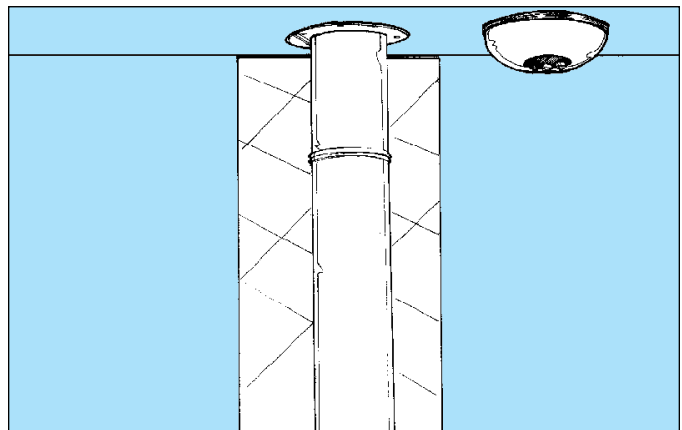

- A heat sensor that sounds an alarm **must** be installed above the stove or near the stove pipe.

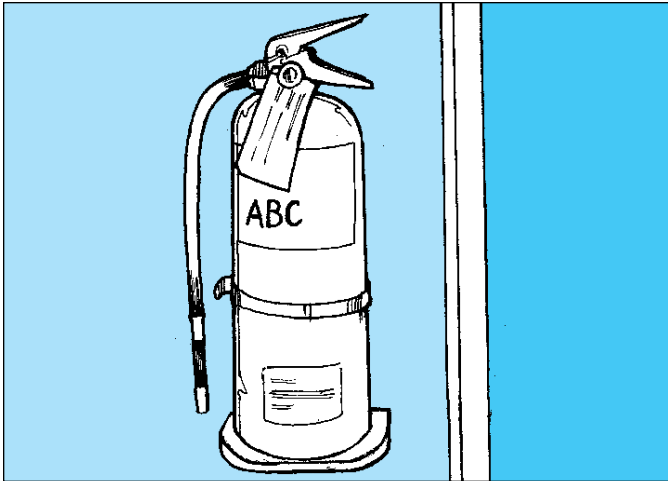

- Keep an ABC or AB fire extinguisher in the galley, near the entrance, if possible. Hang the extinguisher in a bracket, where it can be easily seen and reached.

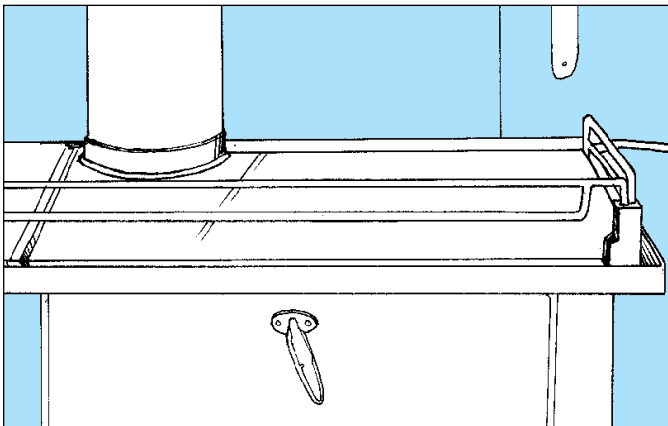

- Galley stoves **must** have guards to stop cooking gear from sliding off the stovetop.

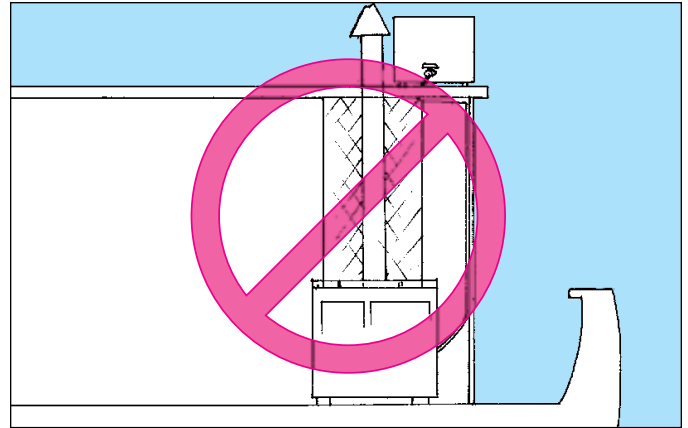

- Stove fuel tanks and lines **must not** be located directly above the stove. A leaking tank or line above the stove can easily catch fire.

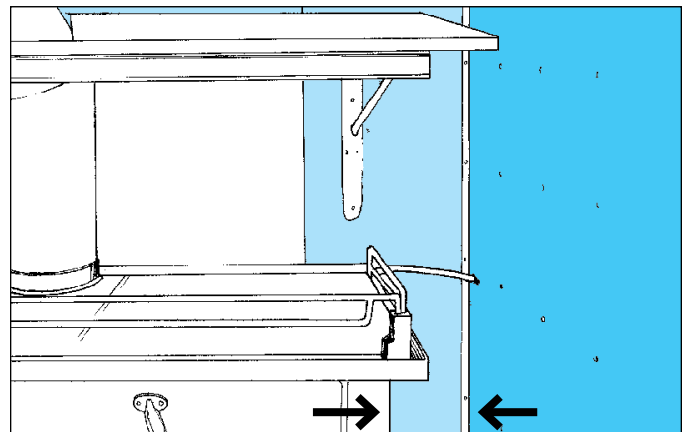

- Galley stoves **must** be bolted down or otherwise secured so they don't slide or move. The space between the stove and the firewalls **must** be large enough to allow you to clean up oil and grease.

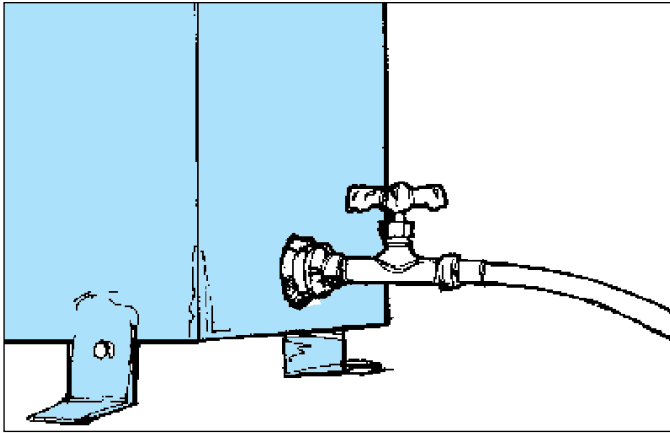

- Stove fuel tanks **must** have a shut-off valve at the tank. The valve allows you to turn off the fuel supply if there's a stove fire, if the stove controls break, or if the stove needs repair. Use proper fuel lines.

Confined spaces

Confined spaces can create unsafe atmospheres, and can cause serious injury or death. Crew members on fishing vessels **must** be made aware of the potential dangers of working in confined spaces.

A confined space is one that:

- Is enclosed or partially enclosed
- Is not intended for continuous human occupancy
- Has limited access that may complicate the provision of first aid, evacuation, rescue, or other emergency response service
- Is large enough that a crew member could enter to perform work

Contact WorkSafeBC for more information about hazards and requirements concerning confined and enclosed spaces or go to www2.worksafebc.com/Topics/ConfinedSpaces/Home.asp.

The atmosphere in a confined space can be dangerous to breathe if there is not enough oxygen in the air, or if there is a buildup of other hazardous gases such as carbon monoxide.

Examples of enclosed or partially enclosed spaces on fishing vessels that are considered confined spaces include:

- Ballast tanks
- Fuel tanks
- Freshwater tanks
- Void spaces

Confined spaces usually do not have adequate ventilation or fresh air for activities such as fibreglassing or welding. Procedures **must** be developed to allow this type of work to take place safely. A confined-space entry program on your vessel **must** include:

- An assignment of responsibilities for the work
- A list of each confined space and a hazard assessment of each space
- Written work procedures for entering confined spaces: These procedures **must** be developed and made available to all crew members. These procedures will address, where applicable:
 - Identification and entry permits
 - Lockout and isolation
 - Verification and testing (air testing **must** be carried out by a trained person)
 - Cleaning, purging, venting, or inerting
 - Ventilation (adequate amounts of fresh air **must** be supplied to the space either by natural or mechanical means to maintain a safe atmosphere to breathe)
- Standby persons (emergency procedures, appropriate equipment, and standby personnel **must** be in place)
- Rescue procedures
- Lifelines, harnesses, and lifting equipment

- Personal protective equipment and other precautions (equipment—such as supplied-air or air-purifying respirators—that meets acceptable standards **must** be provided and worn)
- Coordination of work activities

Crew members **must** be trained and retrained as necessary in confined-space work and emergency response procedures.

Workplace Hazardous Materials Information Systems (WHMIS)

Some materials used on fishing vessels can cause injury or damage health. Some common hazardous materials include:

- Cleaning agents (such as bleach and bilge cleaners)
- Paints and solvents
- Scale, rust, and corrosion removers
- Welding fumes
- Fuel vapours and engine exhaust (such as carbon monoxide)
- Ozone
- Asbestos (found in some older vessels)
- Refrigerant gases (such as freon and ammonia)
- Fibreglass (styrene from polyester fibreglass resin and dust from sanding and grinding)
- Resins and anti-fouling paints

Being exposed to hazardous materials can cause a number of health problems, ranging from eye and skin irritation to organ damage, cancer, or death.

Everyone who uses hazardous materials **must** be trained to use them properly. Crew members **must** also use the personal protective equipment specified in the Material Safety Data Sheets (MSDSs).

Some hazardous materials used on fishing vessels are “controlled products” under WHMIS. Federal and provincial regulations for WHMIS require suppliers to provide proper labelling and MSDSs for their products. In turn, the master **must** ensure that the crew is educated and trained in the safe use of controlled products on board. Controlled products **must** be properly labelled, and the crew **must** have access to the MSDS for each controlled product on the vessel.

Some marine chemicals used on fishing vessels are purchased as consumer products, but still contain hazardous ingredients. The master **must** request the MSDS for these products and follow the same procedures for educating and training the crew.

For all controlled products, containers **must** have the original supplier label. If the material is put in another container, a new workplace label—that you can draw yourself—**must** be applied. This label **must** include the following information:

- Name of product
- Information for safe use, including any personal protective clothing and equipment required
- A statement that an MSDS is available for review

The following is an example of a correct workplace label for acetone, a common solvent.

ACETONE

Flammable

- **Keep away from heat, sparks, and flames**
- **Wear butyl rubber gloves and safety goggles**
- **Use with local exhaust ventilation**

Material Safety Data Sheet Available

Information on labels **must** be easily understood by the crew. Write the labels in a language that crew members can understand.

MSDSs for each controlled product **must** be on board. Available from suppliers of controlled products, the MSDS gives detailed health and safety information about the product, including the following information:

- General product information (the product name, the supplier, etc.)
- Hazardous ingredients
- Physical characteristics (the boiling point, whether it's a gas, liquid, or vapour, etc.)
- Fire or explosion hazards
- Any substances that the product reacts with
- Health effects
- Preventive measures (how to safely handle and store materials and recommended protective equipment such as gloves, respirators, boots, or eyewear)
- First aid procedures
- The date the MSDS was prepared, and contact names and numbers for more information about the product

All crew who use controlled products **must** be trained how to use them properly. Crew members **must** know:

- The hazards of the product
- Required personal protective equipment and other controls to reduce the risk of injury

- Procedures to follow in an emergency such as a spill
- Where to locate the MSDS for more information about the product

For more information about controlled products, WHMIS, and MSDSs, go to www2.worksafebc.com/Topics/WHMIS/Home.asp or contact your nearest WorkSafeBC office.

Hoists and rigging

The importance of inspecting and following safe work procedures regarding the use of vessel rigging cannot be overstated. Fatalities, injuries, lost fishing production, and damaged equipment are just a few of the possible concerns following a rigging failure.

To maintain a safe vessel and ensure the safety of the crew, rigging **must** be inspected. Inspection routines specific to standing and running rigging **must** be established. This includes periodic inspection of your standing rigging and daily inspection of your running rigging. Rigging that is damaged or deteriorated **must not** be used and **must** be replaced with the appropriate rigging. Removal of questionable rigging from service is part of inspection follow-up.

A sample equipment and rigging checklist you can modify to suit your vessel is included on the next page.

Equipment and rigging checklist

Rigging and equipment vary from vessel to vessel. Here's a checklist you can modify to suit the specifics of your vessel.

All rigging **must** be inspected prior to each use and kept in safe working order. Inspect the condition of rigging and equipment to make sure it is safe to use and well maintained.

Item	Comments
Chains, lines, ropes (worn? deterioration?)	
Wire rope (jaggers?)	
Chain links (worn?)	
Shackles, hooks (worn? twisted? moused?)	
Chain plates (rusted? corroded?)	
Cable clips (worn? properly mounted?)	
Blocks (greased? safety lines?)	
Turnbuckles (turn freely?)	
Ropes (spooling properly onto the drum?)	
Winch controls (identified?)	
Blocks (lead to centre of the drum?)	
Anchor winch (safety line for securing the anchor?)	
Drums (hold-to-run controls working? brake adjusted?)	
Power block (safety line installed?)	
Davits (locking device in good repair?)	
Working load limits (written on the boom, shackles, hooks?)	
Equipment controls (clearly marked?)	
Hydraulic power systems (no leaks in lines and fittings?)	
Machinery (properly maintained? guarded?)	
Decks (non-skid where applicable?)	
Wire rope and chain (rated for intended use?)	
Booms (working load limit indicated?)	

Safety procedures and requirements for the hoists and rigging include the following:

- Ensure new crew members are aware of the risks when using rigging, for example, standing in the bight or using the wrong rigging.



- Never stand or walk under a suspended load.
- Never pass a boom—loaded or unloaded—over a crew member, if possible.
- Keep the load as low to the deck as possible:
 - To avoid the risk of lifting the load over crew members
 - To keep the weight low to avoid swing hazards

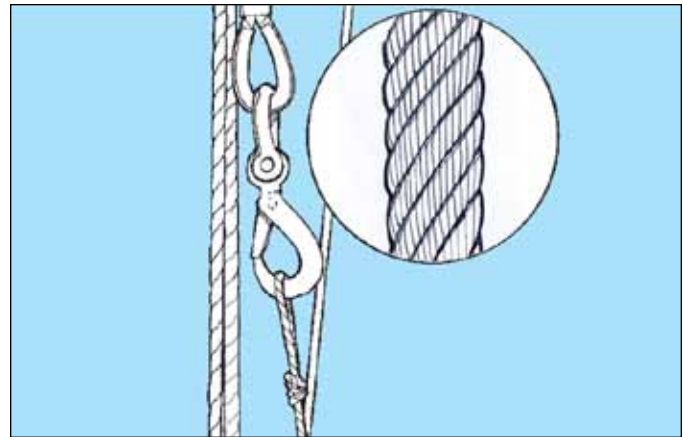

- Rigging including hooks **must** be inspected. Check the hardware, lines, and cables closely for signs of wear or stress. A worn or damaged hook **must** be replaced according to hook rejection criteria.

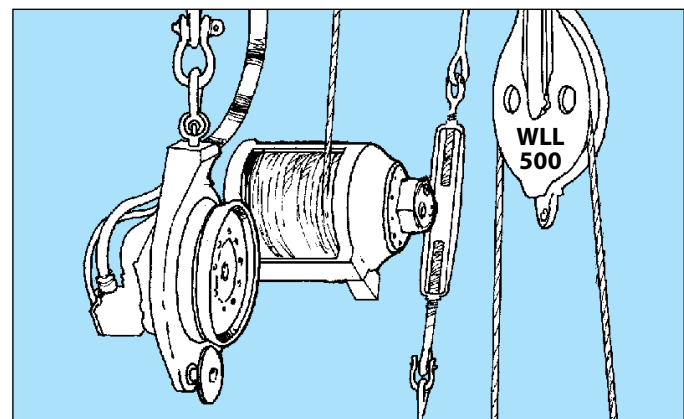

- All rigging—chains, slings, hoists, turnbuckles, derricks, blocks, and anchor gear—**must** be inspected prior to each use and kept in safe working order. Since chains are manufactured for different purposes, make sure the chain is designed for its intended use. Chains used for hoisting **must** be grade 80 or better.

-
- Keep a rigging inventory for maintenance and replacement purposes and to ensure that the proper rigging component is always used in the specific rigging system.
 - Never exceed the working load limit (WLL) – the amount of weight that your boom, rigging, shackles, blocks, and other equipment is rated to handle safely. Lifting loads that weigh more than the rated capacity can cause equipment failure, which can lead to accidents and injury.

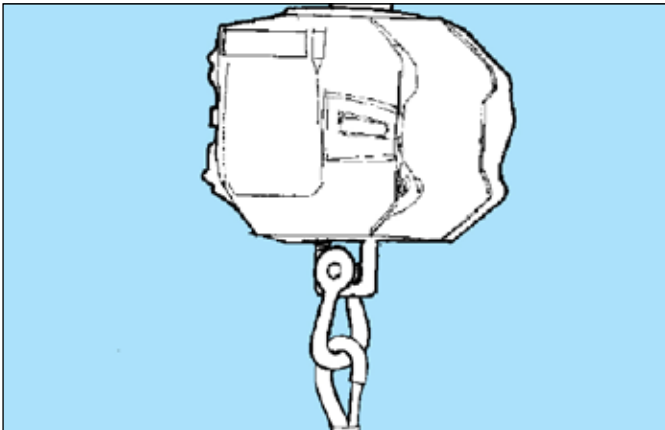

- Use a rated shackle or hook with a safety latch to attach the scale to the brailer. An open hook can slip, especially in heavy swells. When this happens, the hook or the bag can hit crew members.

Rigging requirements are set out in Part 15 of the Occupational Health and Safety Regulation.

Directing Winch or Crane Operations



Hoist



Lower



Raise boom



Lower boom



Move slowly



Swing



*Raise the boom and
lower the load*



*Lower the boom
and raise the load*

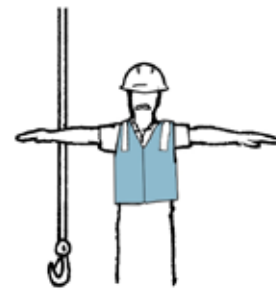

Stop



Dog everything

Machinery

Equipment is only as good as the people who operate it. Never use a machine if you don't know how to operate it properly. If you see machinery that needs repair, report it to the master for immediate repair.

Other procedures and requirements for safety around machinery include the following:

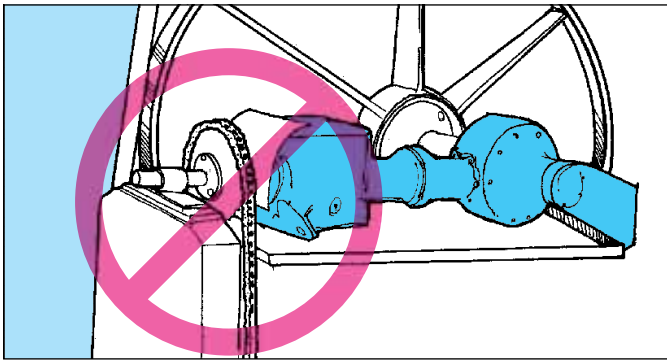

- Moving parts of power-operated equipment—such as chain and belt drives, gearing, and shafting—**must** be guarded to avoid allowing hands, hair, or clothing to be caught. (Equipment such as a capstan can't be guarded because of the way it operates.)

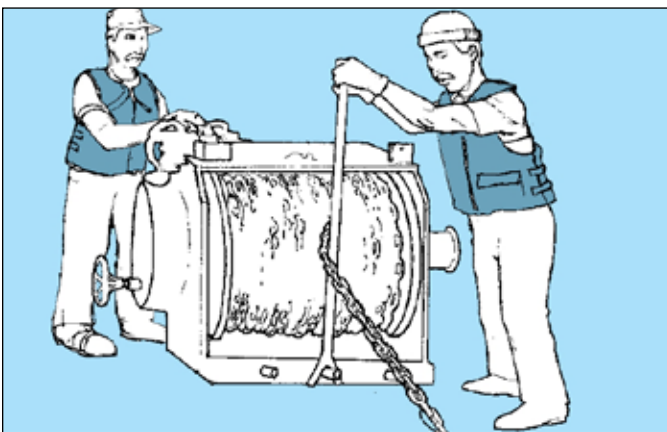

- Use a tool, not your hands or feet, to guide the lines. Otherwise, you may get caught in a line and dragged into moving equipment.

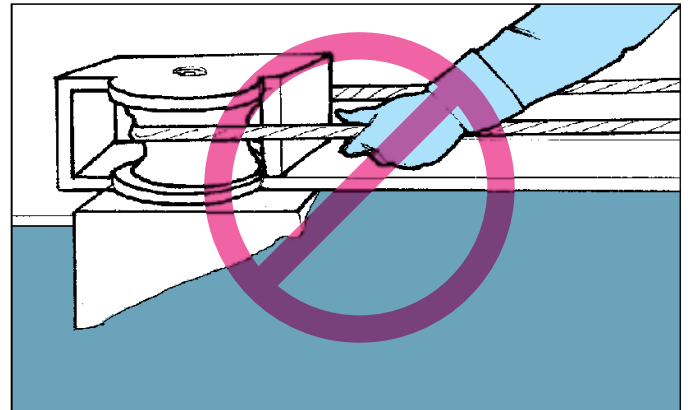

- Never use moving lines as a handhold.

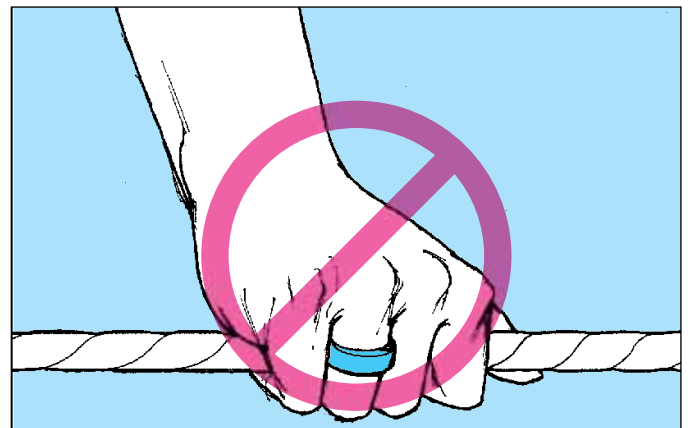

- Avoid wearing rings. They can get caught in lines, nets, and other gear and equipment.

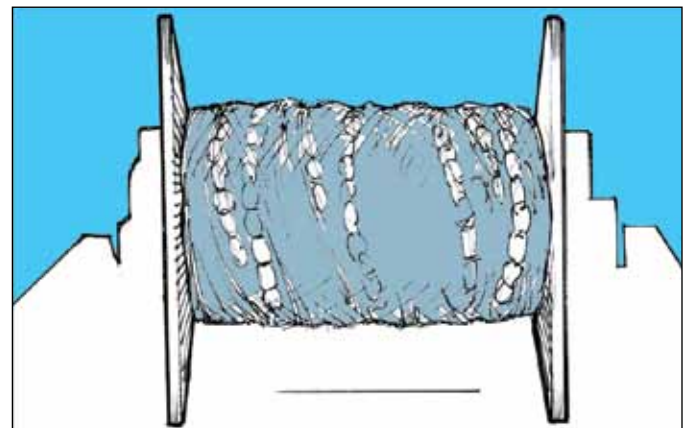

- Spool nets on drums or cables on winches evenly to prevent backlashes.

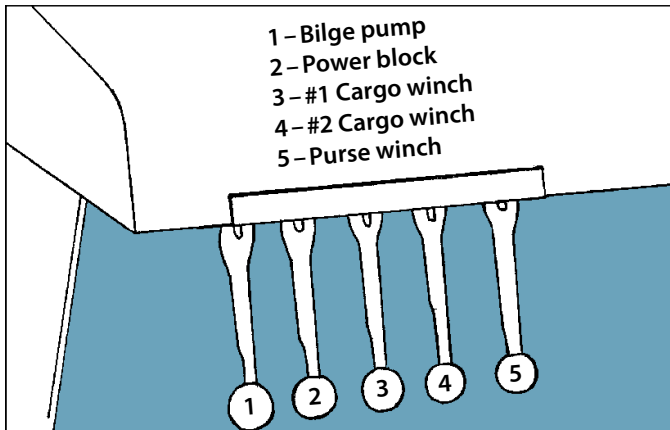

- Make sure all equipment controls are clearly marked.

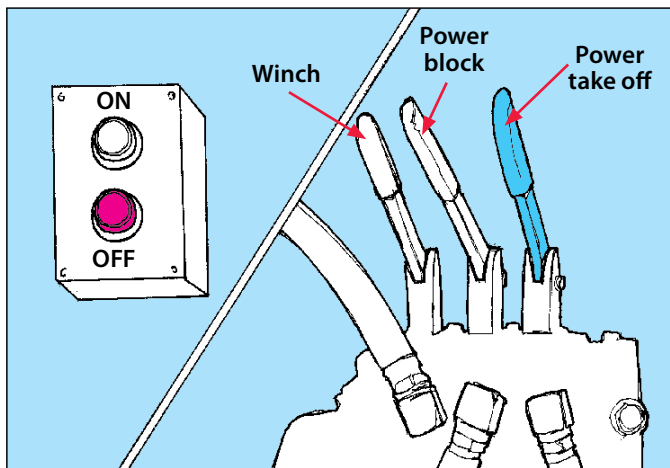

- Winches, drums, capstans, and similar equipment **must** have a master on/off switch on deck that is easy to reach. This ensures equipment can be stopped quickly if someone gets caught in it. Make sure the switch is clearly marked and crew members know where to find it.
- An additional switch in the wheelhouse is good practice.

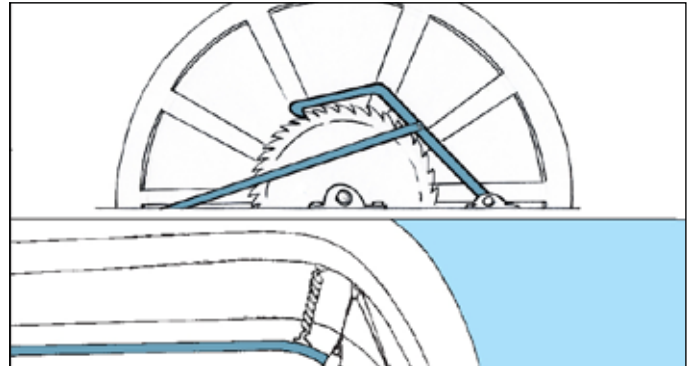

- Drum pedals and other types of hold-to-run controls on a gillnet vessel **must not** be bypassed.

Lockout

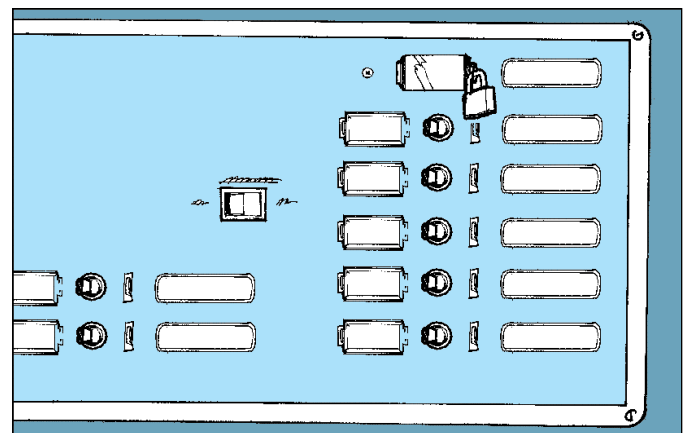

Before repairing any machinery you **must** disconnect the power. For repair, machinery **must** also be secured—for example, by locking out the power source—to prevent accidental start-up. (In some situations, as in heavy weather, shutting down equipment may be unsafe. Only in such cases can these safety steps be bypassed.) If equipment or machinery has to be kept operating during maintenance, procedures **must** be put in place to prevent injury from moving or energized parts.

Documentation

A fishing vessel owner **must** keep documentation on board and make it available to all crew members. The owner **must** discuss the features of the vessel with the master who will review them with the crew. At a minimum, documentation **must** cover the following categories:

- **Engine room instructions**

Examples of useful documentation include procedures for starting and stopping the engine, putting out engine room fires, de-energizing equipment, and using the bilge blower (if equipped), maintaining the shaft, and checking the bilges.

- **Vessel characteristics**

Examples of useful documentation include the stability booklet for the vessel, and operational and stability considerations for any major modifications to the vessel. Other useful documentation on vessel characteristics include:

- Working load limits for lifting equipment
- Pumping systems and procedures
- Safe fuelling procedures
- Procedures for de-energizing equipment
- Procedures for testing equipment
- Minimum freeboard under loaded conditions
- Procedures for loading fish, including maximum loads
- Operating practices such as lowering the boom when travelling, avoiding slack tanks, and keeping weights low

- **The location and use of firefighting equipment**

Examples of useful documentation include operating instructions and records of equipment maintenance and testing.

- **The location and use of emergency equipment including radios**

Examples of useful documentation include:

- Instructions on how to use and maintain immersion suits, personal flotation devices, lifejackets, life rafts, flares, and emergency beacons
- Instructions on how to use the radio to send a request for assistance or to send a distress call.

Tips from fishermen — for all vessel types:

- Know the boat.
- Know where your crew is when travelling.
- Don't stand in the bight of a line.
- Get lots of sleep.

When in doubt, wake the skipper up.

If it looks like it's going bad, it is.



Safety Equipment



* Nota: El buque debe estar equipado con un sistema de comunicación por radio VHF.

 * Nota: El buque debe estar equipado con un sistema de comunicación por radio VHF.

 * Nota: El buque debe estar equipado con un sistema de comunicación por radio VHF.

Nota: Información - MANTENIMIENTO DEL BUEQUE

SELECCIÓN DE EQUIPO	Mantenimiento del Bueque					
	Motor	Transmisor	Receptor	Antena	Alimentación	Accesorios
Motor	15 HP	15 HP	15 HP	15 HP	15 HP	15 HP
Transmisor	15 HP	15 HP	15 HP	15 HP	15 HP	15 HP
Receptor	15 HP	15 HP	15 HP	15 HP	15 HP	15 HP
Antena	15 HP	15 HP	15 HP	15 HP	15 HP	15 HP
Alimentación	15 HP	15 HP	15 HP	15 HP	15 HP	15 HP
Accesorios	15 HP	15 HP	15 HP	15 HP	15 HP	15 HP

BANKS ISLAND

First aid

Fishing vessels **must** comply with the First Aid requirements in Part 3 of the Occupational Health and Safety Regulation.

Good first aid skills can mean the difference between life and death, or between short-term and life-long injury. Learn as much first aid as you can. At sea, you have only yourself and other crew members to turn to for help. If an injury happens, record it. Report all serious injuries to WorkSafeBC. When assessing first aid and injury-reporting procedures, keep these safety steps and requirements in mind.

First aid kits

Before the start of the fishing season, check your first aid kit to make sure it's fully stocked. All fishing vessels with 2 to 15 crew members **must** carry a Level 1 first aid kit.

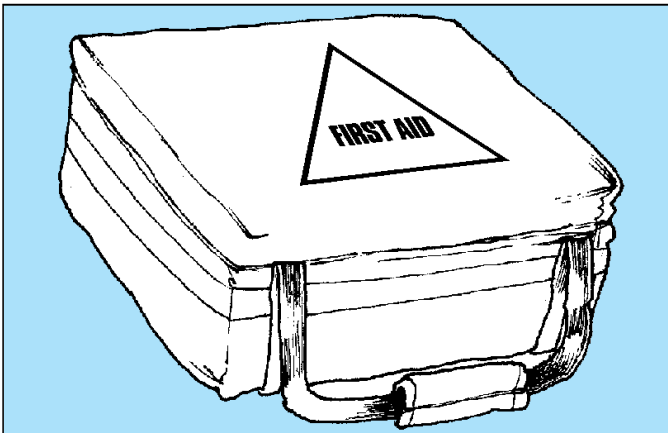

Vessels run by only one crew member **must** have a personal first aid kit.

Carry a first aid manual on the vessel at all times. It's best to keep it in the first aid kit, where crew members will know to find it in an emergency.

For more information on first aid and first aid supplies, go to www.worksafebc.com or contact your nearest WorkSafeBC office.

Training

If a vessel has two or more crew (including the master), at least one crew member **must** have completed the one-day level 1 first aid certificate course and the one-day transportation endorsement course, or the two-day marine basic first aid course or four-day marine advanced first aid course.

If a vessel has only a single operator, he or she is not required to have first aid qualifications, but having them would be beneficial.

First aid records

All injuries that are treated or reported **must** be recorded. Each record of injury **must** contain the following information:

- The full name of the injured crew member
- The date and time of the injury or illness
- The date and time the injury or illness was reported to the master
- Names of witnesses
- How the injury or illness happened
- A description of the injury or illness
- Initial and follow-up treatment, or other arrangements made for the injured crew member
- The signature of the person giving first aid and, when possible, the signature of the person receiving treatment

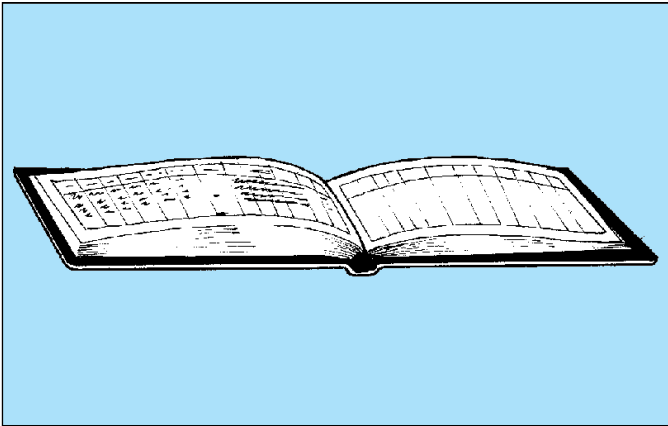

All injuries **must** be recorded. This can be done in the vessel log book or in a treatment record book. First aid records **must** be kept for 10 years.

Crew **must** report all injuries to the master. In turn, the master **must** report all injuries that require medical aid to the vessel owner. All injuries resulting in death or serious injury **must** be reported to WorkSafeBC.

The vessel owner pays for transporting an injured worker to a medical facility for treatment.

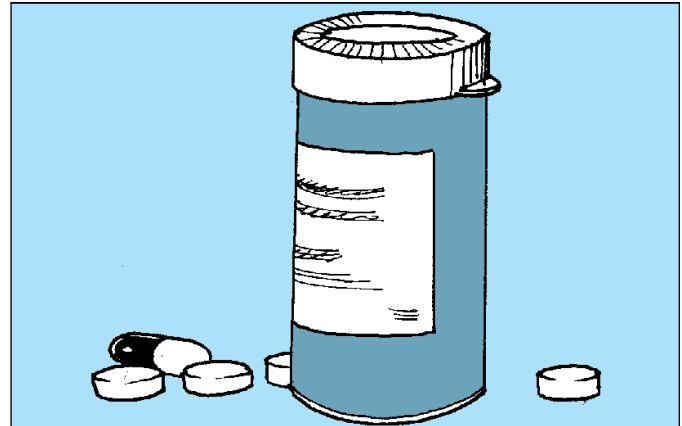

All crew members **should** tell the master and other crew members if they have allergies or have special medication requirements or health issues.

It's a good idea to document individual crew health concerns and emergency contact information in your safe work procedures manual.



Fish SAFE's resource *Safe at Sea* includes a template for recording the crew health specifics for your vessel. Contact Fish SAFE for more information at 604 261-9700 or online at www.fishsafebc.com.

Ventilation

Take a close look at the ventilation system and installations on your vessel. Good venting provides fresh air needed for good health. Properly mounted and maintained installations, such as propane tanks and ozone generators, are less likely to leak.

Follow these safety steps and requirements for proper ventilation:

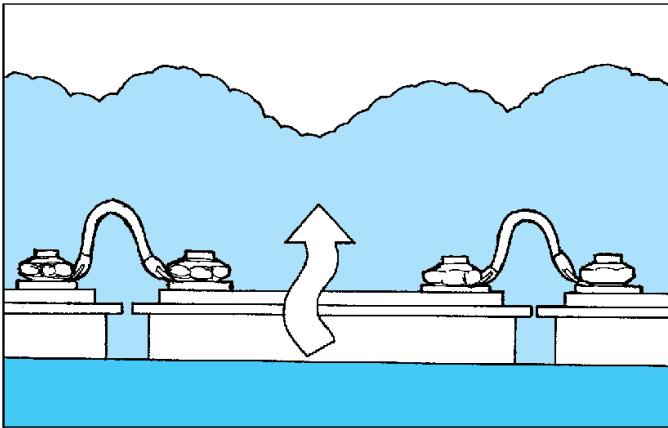

- Vent the battery storage area. Batteries give off toxic, explosive gas.

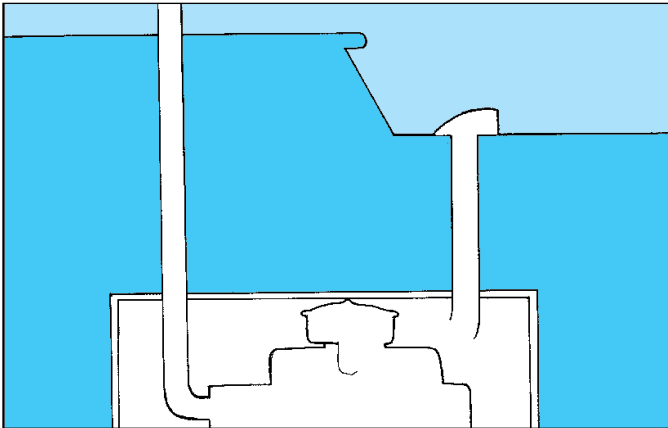

- Vent all closed spaces with gasoline engines. Exhaust gases or fuel vapours can be deadly if allowed to build up.

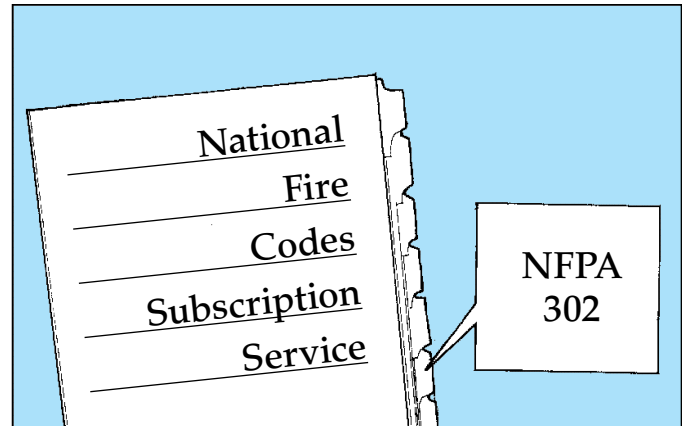

- Be sure that installations for propane, compressed natural gas, and liquefied petroleum gas used for fishing vessel appliances are safe and in good repair. Such installations **must** conform to the most recent edition of National Fire Protection Association Standard 302: Fire Protection Standard for Pleasure and Commercial Motor Craft.

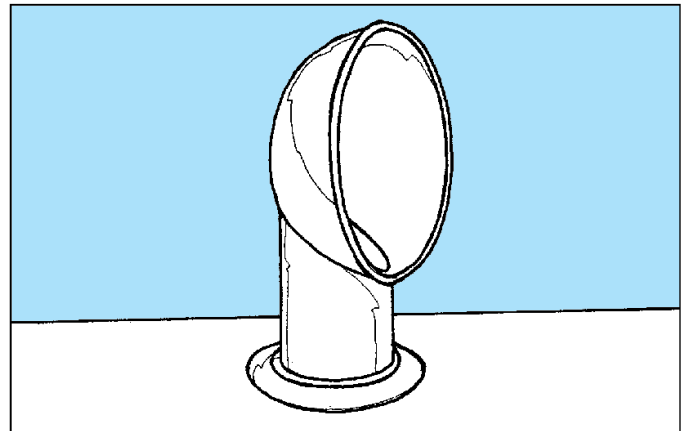

- Crew sleeping quarters **must** have adequate fresh air. Good ventilation helps maintain good air quality.

Ozone safety

Ozone used to treat water in fish holds can pose risks to crew. Being exposed to unsafe levels of ozone gas can, over time, cause lung damage and other health problems. The immediate effects of exposure to high levels of ozone include nausea, vomiting, pain or tightening in the chest, lung damage, and even death.

At low levels (about 0.1 ppm), ozone can cause headaches and shortness of breath.

Equipment that produces ozone **must** be safely installed and operated to prevent leaks and other malfunctions. On a fishing vessel, the ozone generator and the concentrator **must** be in their own enclosed areas or a bulkhead that is vented to the outside.

Ozone has a strong smell all its own. However, don't use your nose to warn you of high ozone levels—the nose quickly loses its ability to smell the gas. Testing equipment **should** be used to monitor the air in work areas where ozone-generating equipment is operating. Crew members **must** be trained in the emergency procedures to follow if there is an accidental release of ozone.

Because ozone is a controlled product under the Workplace Hazardous Materials Information System (WHMIS), a Material Safety Data Sheet (MSDS) for ozone **must** be kept on board for the crew to read. The MSDS gives key information about a product, including its health effects, first aid treatment, and ways to prevent being exposed to unsafe levels.

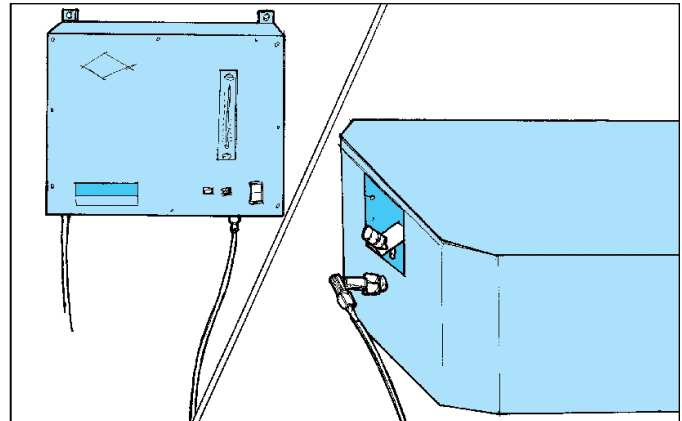

Follow the manufacturer's instructions, and check all hoses. They can become hard and cracked, causing leaks of ozone or pure oxygen from the concentrator. Leaks of oxygen can cause a fire or explosion.

For more information on standards covering ozone and ozone generators, go to www.worksafebc.com/publications/health_and_safety/by_topic/assets/pdf/ozone_bk47.pdf or contact your nearest WorkSafeBC office.

Life rafts

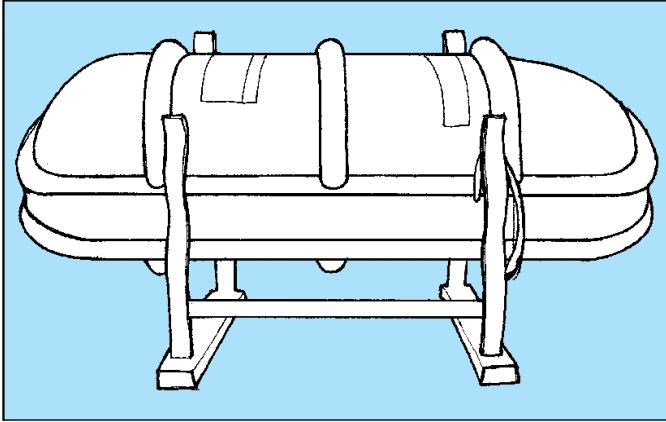

Life rafts **must** be stowed in a manner which allows for their effective deployment. Some examples include placing them:

- In deep chocks without lashing, or
- Secured by a lashing fitted with a hydrostatic release unit, which will automatically release the life raft from a sinking vessel, and
- Where they can be easily launched and away from entanglements

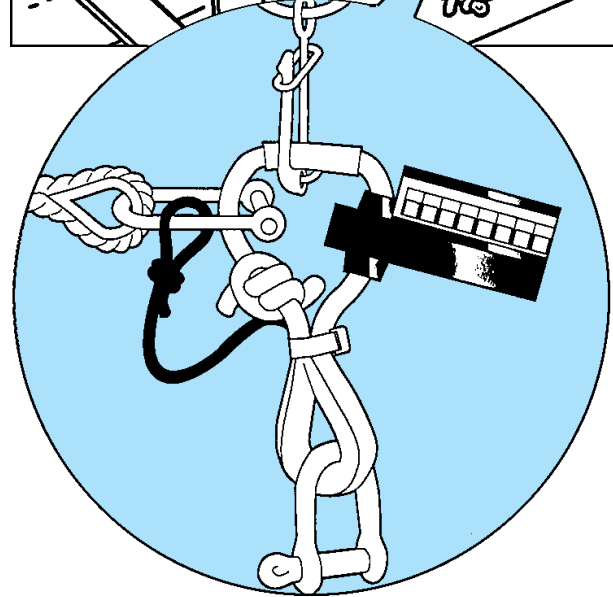
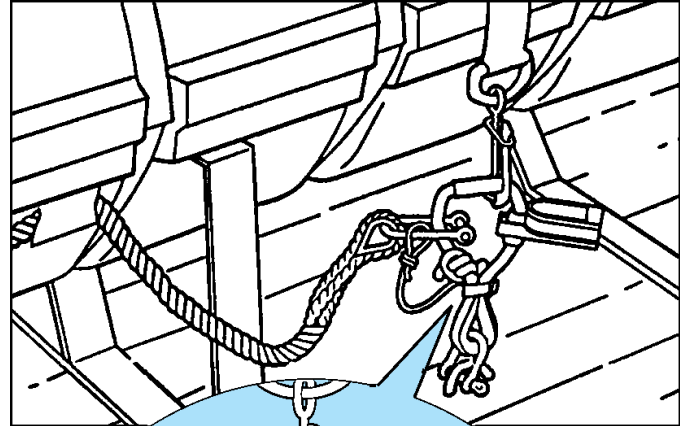

The proper installation of a hydrostatic release

Personal protective equipment

Personal flotation devices (PFDs) and lifejackets



All crew members **must** wear an approved PFD or lifejacket when working on the deck of a fishing vessel or in a seine skiff, as there is a risk of drowning. Whatever flotation device you choose **should** be the right device for the job. It **should** fit and be comfortable to work in, while meeting the following requirements:

- Your PFD or lifejacket **must** provide a minimum buoyancy of 69 Newtons (15.5 pounds). A device with a buoyancy rating of 69 Newtons (15.5 pounds) is designed to keep a conscious person's head above the water.
- If you are working alone, you **must** wear a self-righting PFD or lifejacket with a minimum of 93 Newtons (21 pounds) of buoyancy. These devices are designed to provide enough support for the head, neck, and chest to turn an unconscious person face up in the water (self-righting). Working alone means you are not within eyesight or earshot of another worker – no one could immediately come to your aid if you fall in the water.
- So you are easy to spot if you fall overboard, your flotation device **must** have white or silver retro-reflective material fitted on the surfaces that normally remain above the water's surface. It's good practice to wear reflective tape on your clothing too.

- If your PFD or lifejacket is not inherently buoyant, it **must** be automatically inflatable and **must** also have a manual inflation system. Manual-only inflatable devices are not acceptable.
- Wear your auto-inflatable flotation device overtop of your clothing. Don't attach anything to it that might prevent it from inflating when needed.

Check that your device meets a standard acceptable to WorkSafeBC. Refer to Part 8 of the Occupational Health and Safety Regulation. (See guidelines 8.26 to 8.28 about buoyancy equipment at www2.worksafebc.com/publications/OHSRegulation/GuidelinePart8.asp.)

Immersion suits

An immersion suit is designed to save your life if you are forced to abandon ship in an emergency. Without protection, you can drown within a few minutes from the shock of entering cold water. An approved immersion suit acts like your own personal life raft, keeping you afloat and keeping your body heat inside the suit and cold water out. It also provides a large, highly visible target for rescuers.

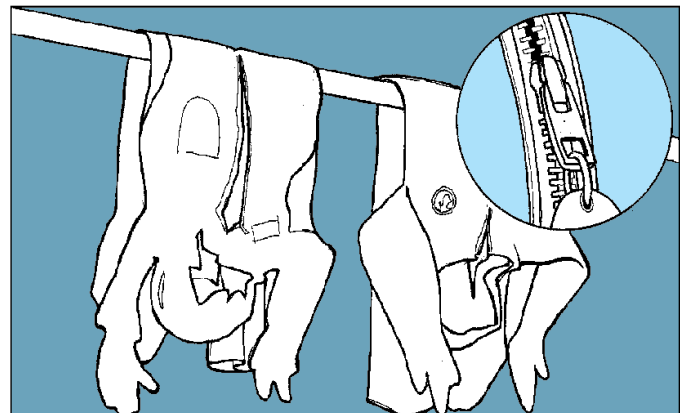

Ensure your immersion suit is properly maintained. Check that the seals and seams are not damaged and the zipper functions properly.

The master of the vessel **must**:

- Make sure there are immersion suits that are in good repair, well maintained, and of proper size readily available on board for you and all crew members (this does not apply to skiffs or punts working near the main vessel).
- Conduct emergency drills that include practising putting on your immersion suit at least annually – at the start of the fishing season before leaving the dock, when there is a crew change, and at intervals to ensure that crew members are familiar with emergency procedures.

Worker responsibilities are to:

- Check that your immersion suit meets WorkSafeBC requirements.
- Know where your immersion suit is kept and how to wear it.
- Practise putting on your suit and participate in emergency drills.
- Regularly inspect your suit to make sure it fits properly and is in good working condition.
- Report any damage to the vessel master.
- Wear your immersion suit for abandoning ship.

Since it is your life that is at stake, you may choose to provide your own suit to ensure good quality, fit, and maintenance. Remember: Your immersion suit can only save your life if you use it.

Head, eye, and face protection

There are many hazards to your head, eyes, and face on a commercial fishing vessel. Personal protective equipment can protect you from injury.

The following instructions are for using personal protective equipment on fishing vessels:

- Safety headgear (hard hat) **must** be worn when working under moving equipment or objects that could fall, for example, when unloading and piling nets.



- Secure the chin strap when working at heights over 3 metres (10 feet) and in rough weather.



- Wear eye protection appropriate for the job. For example, safety glasses with side shields or goggles when grinding, working with loose or pointed objects, or when exposed to jellyfish.

When working with a hazardous product, check the Material Safety Data Sheet or product label to determine whether eye and face protection are required.

- Consider tinted safety glasses or sunglasses to reduce sun glare.
- Wear a hat (baseball cap, hard hat, or other brimmed headwear) to protect your eyes and face from the sun, even on overcast days.

Hand protection

There are many hazards to your hands on a commercial fishing vessel. Personal protective equipment can protect you from injury.

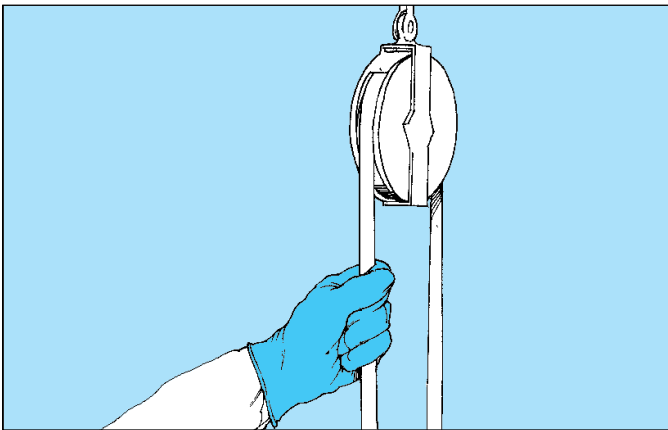

Wear gloves when handling rope. Wire rope may have jagers – broken wires that poke out – which can cause cuts or lodge in the skin. All types of rope can cause skin burns.

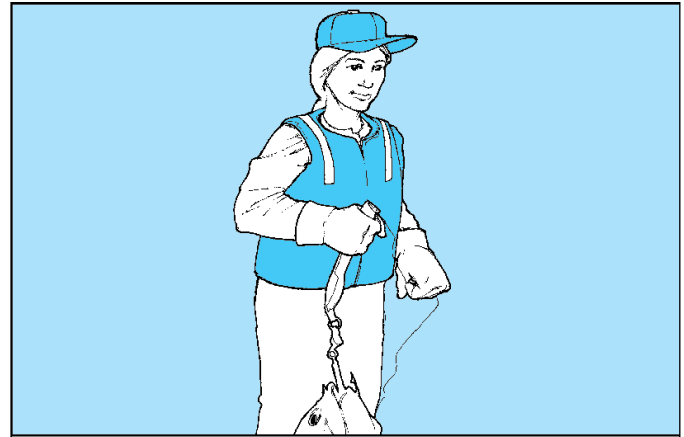

When handling (jigging for fish) you **must** wear gloves that will adequately protect your hands.

Choose the right gloves for the job:

- Wear good quality rubber gloves for protection against dampness, fish spines, and the cold, and when handling gear such as nets and lines.
- Wear cloth gloves under rubber gloves for comfort.

Consider wearing gloves and/or protective sleeves whenever there is a chance that your skin could be damaged by equipment, gear, or fish. For example, wear gloves and/or sleeves when:

- Handling hooks or fish
- Chopping bait
- Hosing down decks
- Seining, during beach tie-ups, to prevent cuts from barnacles

Footwear

Using the appropriate footwear can help prevent injuries on the job:

- Wear waterproof, non-slip footwear such as rubber boots with suction soles if the deck surface is slippery.
- Use rubber bands around the tops of your boots and the bottoms of your rain gear. This helps to keep out water, holds loose clothing to your body, and prevents raingear from restricting leg movement.
- For seining, during beach tie-ups, wear boots to prevent slipping on seaweed and slippery rocks.

Hearing protection

Loud noise is common on a commercial fishing boat. Long-term exposure to noise can result in hearing loss.

The following requirements and recommendations can help you protect your hearing:

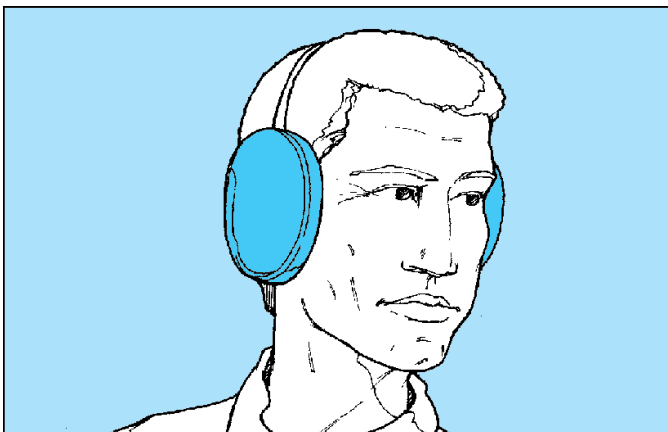

- You **must** wear hearing protection such as earmuffs or earplugs if you will be exposed

to loud noise for extended periods. Regular earmuffs or earplugs may not be the right choice. They may block out too much sound for you to communicate effectively with other crew members. There are earmuffs and earplugs that are designed to permit you to hear equipment and people while reducing noise. Consider wearing this type of hearing protection while sleeping as well.

- Ear buds or headphones for listening to music are not approved hearing protection and may prevent you from hearing emergency warnings or communications with co-workers. In addition, listening to loud music through ear buds may damage your hearing.

Typical fishing vessel noise levels

Noise-induced hearing loss is caused by extended periods of exposure to noise above 85 dBA.

Compressor	90–105 dBA
Deck	88–100 dBA
Engine Room	90–114 dBA
Galley	75–80 dBA
Sleeping quarters	50–80 dBA
Vessel repairs	70–100 dBA
Wheelhouse	80–90 dBA
Winch	90–100 dBA

- You **must** wear hearing protection when working in the engine room. Many people in the industry have damaged their hearing by not wearing ear muffs or ear plugs.
- You **must** get an annual hearing test if you are exposed to daily noise levels above 85 dBA.

Sensors and alarms

Sensors and alarms are useful only if they work. Don't disconnect them or let them fall into disrepair. Keep your sensors and alarms well maintained, and test them regularly. Don't bypass them.

Other requirements for sensors include the following:

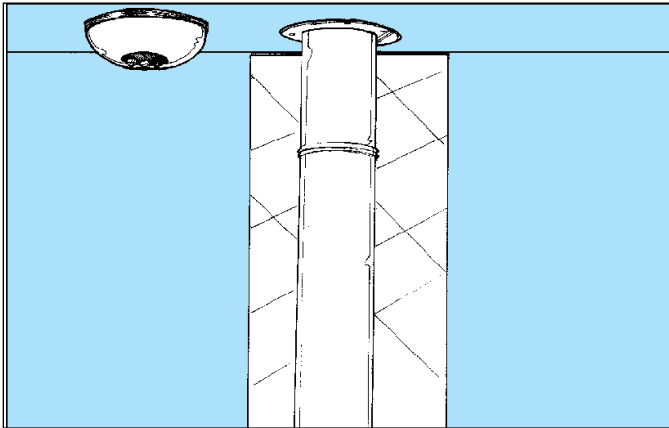

- A heat sensor that sounds an alarm **must** be installed above the stove or near the stove pipe.

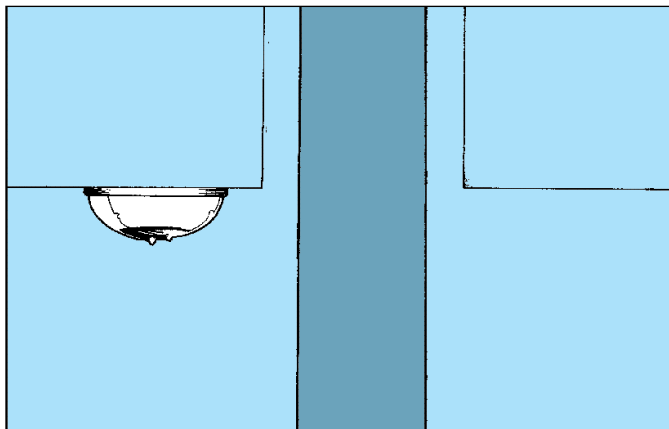

- A heat sensor that sounds an alarm **must** be installed near the engine exhaust.

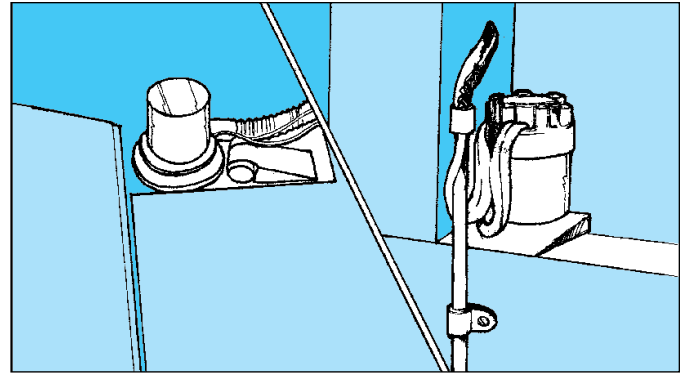

- To warn of flooding or high water levels, water-level sensors that sound an alarm **must** be installed in the engine room bilges and in the shaft log or the lazarette.

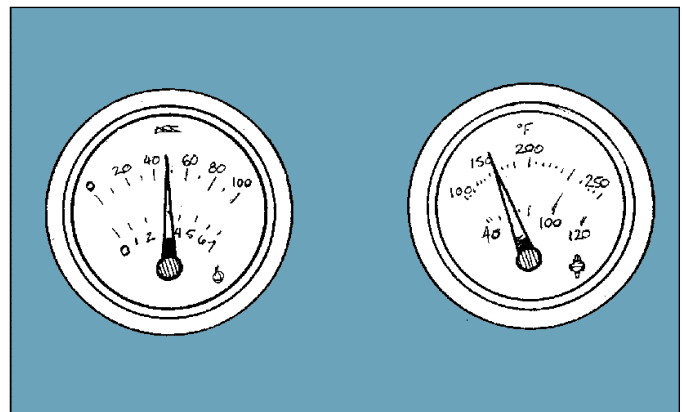

- To warn of possible engine failure, engines **must** have sensors for low oil pressure and high water temperature. These sensors **must** sound an alarm.
- A smoke detector is recommended as an early warning device.

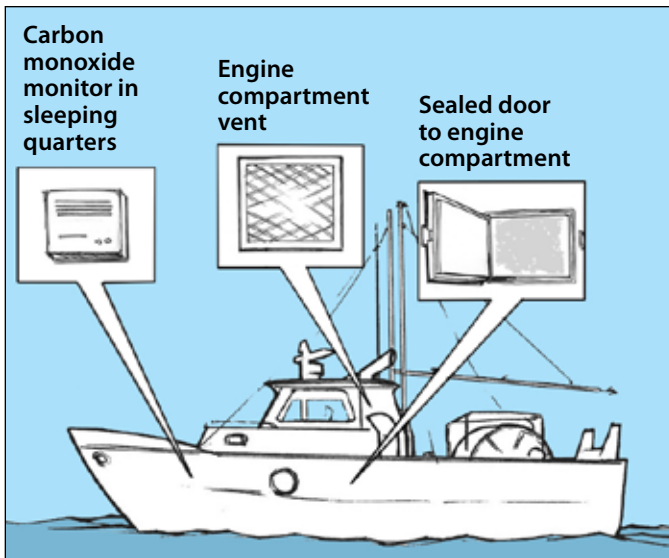

- To warn of possible carbon monoxide exposure, an audible marine grade carbon monoxide sensor, connected to an alarm system where practicable, **must** be installed in the crew quarters.

Safety by Gear



ING



Table with 10 columns and 2 rows of data, likely representing vessel specifications or performance metrics.

SELECTION	Length	Beam	Depth	Weight	Power	Speed	Range	Capacity	Notes
1	24.4	5.4	2.8	18.7	5.5	3.8	12	12.5	

Dive

Seafood harvesters who use scuba or surface-supply diving gear **must** be trained in the equipment and procedures necessary for their particular diving activities. Divers **must** meet the minimum requirements of CSA Standard Z275.4: Competency Standard for Diving Operations. By law, a copy of the WorkSafeBC Occupational Health and Safety Regulation **must** be on hand at all dive sites. For all diving operations, minimum crew requirements **must** be followed, and a diving supervisor **must** be on-site and in control.

Other dive requirements include the following:

- Owners and masters **must** ensure that all divers have adequate training and know how to use available diving gear. An original or notarized copy of competency documents **must** be available at the dive site.
- Owners and masters **must** ensure all divers have current medical certification prior to entering the water. Certification **must** be from a physician knowledgeable and competent in diving medicine. The original or a copy of the medical certificate **must** be available at the dive site.

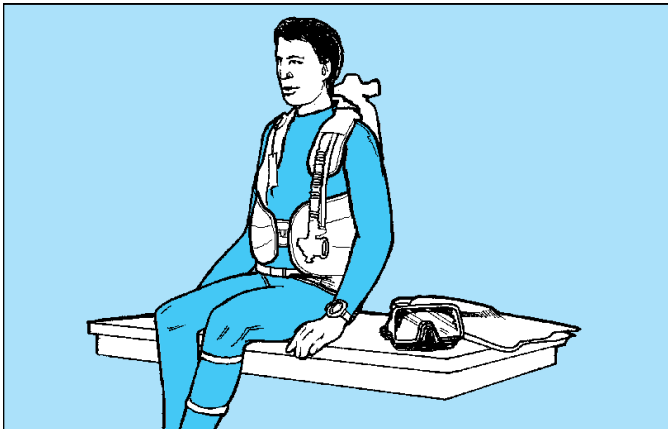

- When diving is in progress, a dressed-in, standby diver **must** be on the dive site at all times to give emergency aid, if needed. The standby diver **must** be able to enter the water within one minute.

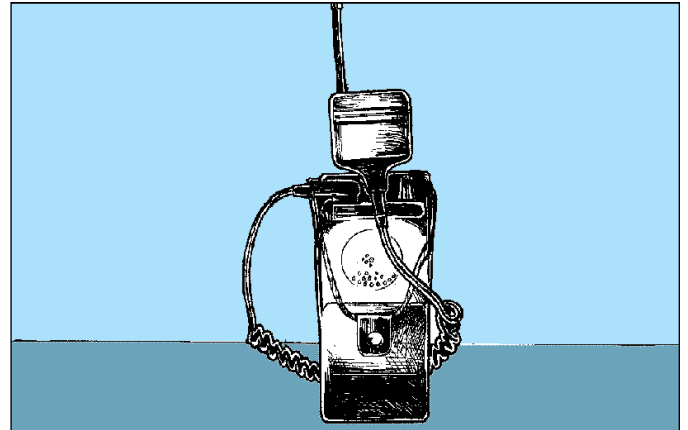

- Each dive site **must** have a radio or a phone to allow voice contact with emergency services.

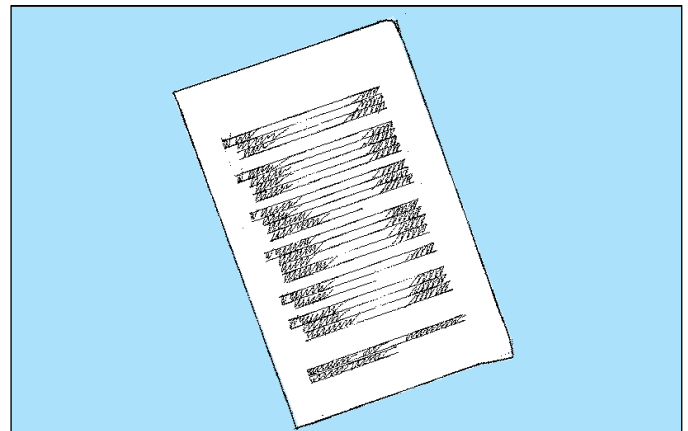

- Each dive site **must** have an up-to-date list of the locations and telephone numbers of nearby facilities with recompression chambers, and numbers for emergency services such as the Canadian Coast Guard, medical airlifts, and doctors knowledgeable and competent in diving medicine.

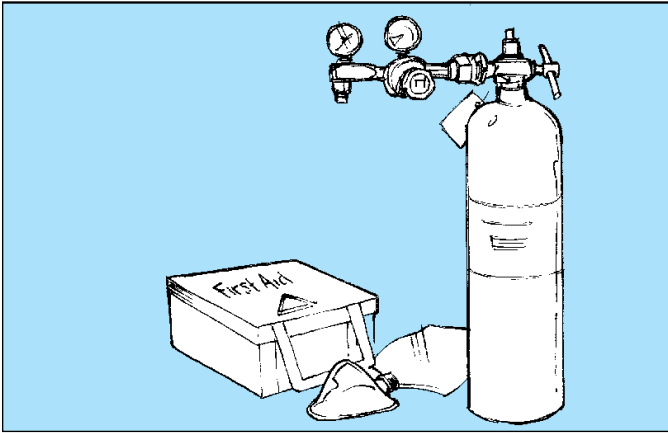

- Dive sites **must** have all necessary first aid equipment, including sufficient oxygen to reach emergency services. Each diver **must** be qualified in CPR, oxygen therapy, and dive accident management. CSA Standard Z275.4 for diving operations requires each diver to have a current occupational first aid ticket.

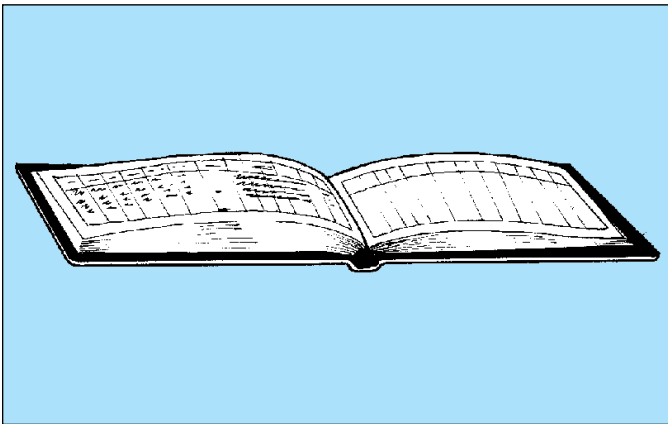

- Both the diving supervisor and the diver **must** keep separate diving logs. The log books **must** include the type of apparatus and gas medium, times, maximum depth, surface interval, decompression tables used, date, and remarks. Both logs **must** be on-site and the diving supervisor's log **must** be filed with the employer after the dive.

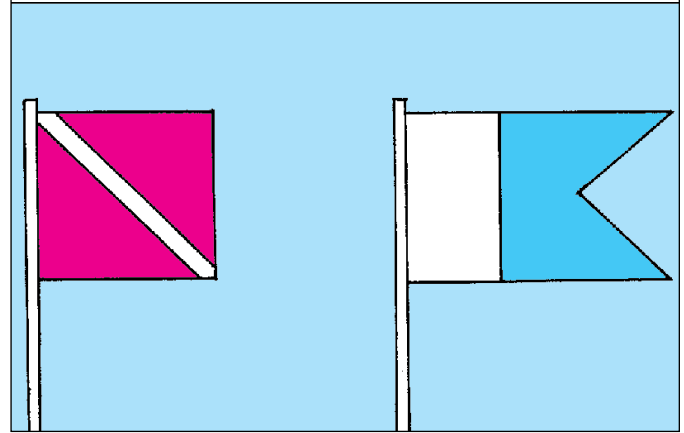

- In navigable waters, the recognized diver's flag (left) **must** be flown or displayed. Some authorities may require vessels engaged in diving operations to show the International Code "alpha" flag (right). Show diving flags **only** while diving operations are in progress. Remove them when diving has stopped and there are no divers in the water.

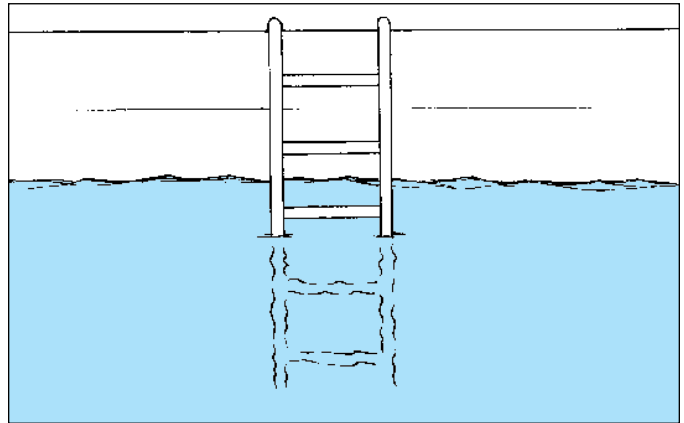

- There **must** be a safe means for divers to enter and exit the water, usually a ladder. The ladder **should** extend far enough into the water so that the diver can easily climb back onto the boat. If the ladder is too short, the diver may be injured getting aboard.

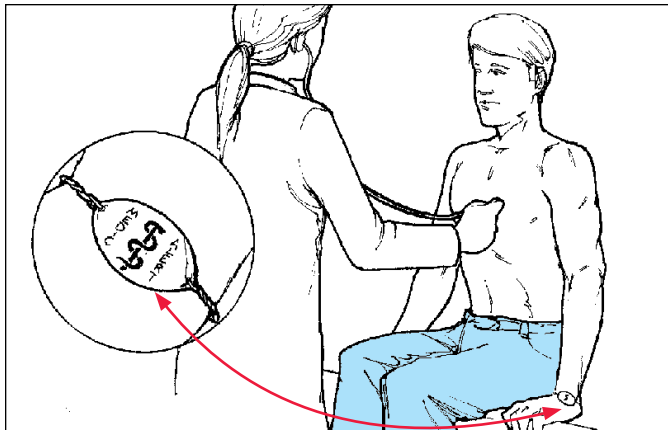

- Divers aged 40 and over **must** be examined at least once every year by a doctor knowledgeable and competent in diving medicine. Divers aged under 40 **must** be examined every two years. Divers **must** wear a medical alert tag for at least 24 hours after each dive. These tags will state that the wearer may be susceptible to diving illnesses such as decompression sickness.

Scuba diving

Getting trapped under water and rising too fast to the surface are among the most dangerous hazards for scuba divers. Scuba diving requirements include the following:

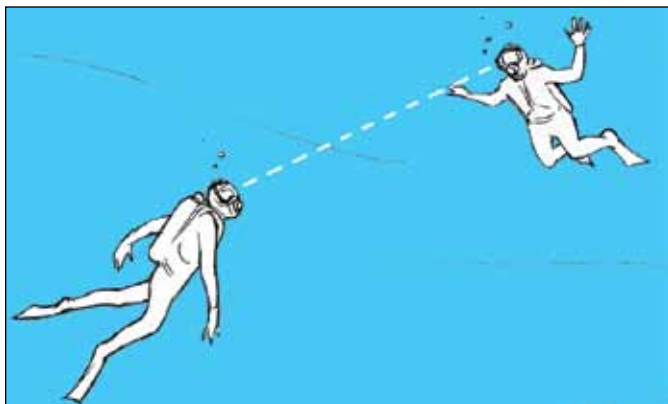

- Each diver using scuba **must** employ the buddy system and have visual communication or physical contact at all times, or



- Each diver **must** be tended on a lifeline by a diver's tender, or

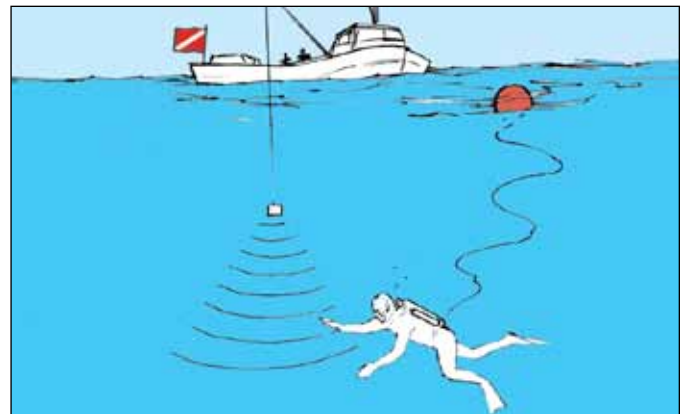

- Each diver **must** be in constant audio communication with the surface, or

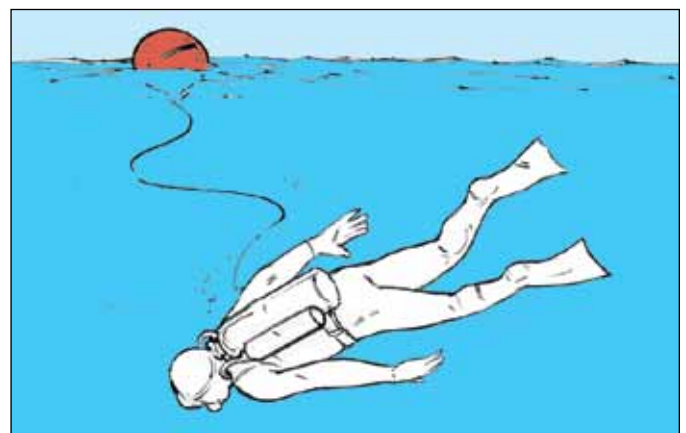

- Each diver **must** be tethered to a float that is constantly visually monitored.

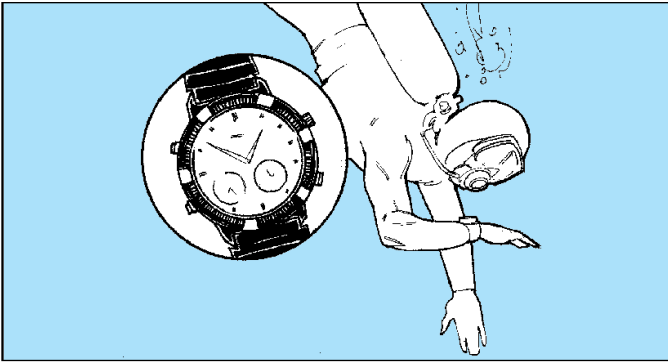

- Divers **must not** stay at any depth longer than the maximum time planned.

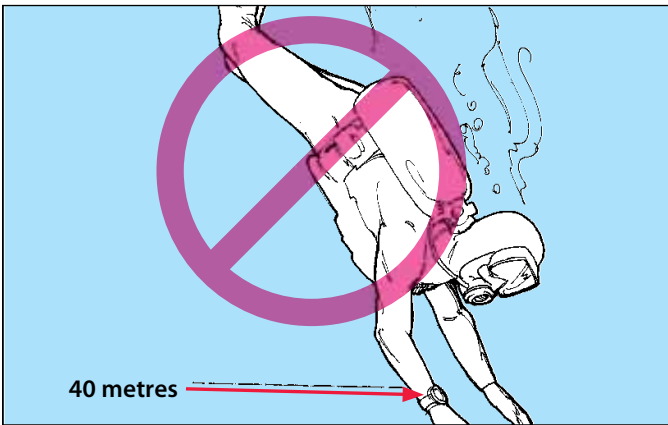

- Scuba divers **must not** dive deeper than 40 metres (130 feet).



- Scuba cylinders **must** be visually inspected internally every year. Cylinders **must** be hydrostatically tested every five years. Inspection and testing results **must** be documented in an equipment log book and **must** be available at the dive site.

At a minimum, scuba divers **must** use the following equipment as appropriate to the diving conditions and as specified by the diving supervisor:

- Scuba unit with a quick-release harness and a pressure gauge
- Face mask
- Swimming fins
- Diving knife
- Depth gauge
- Exposure suit
- Inflatable buoyancy device
- Underwater watch with an elapsed-time indicator
- Weight belt with a quick release buckle

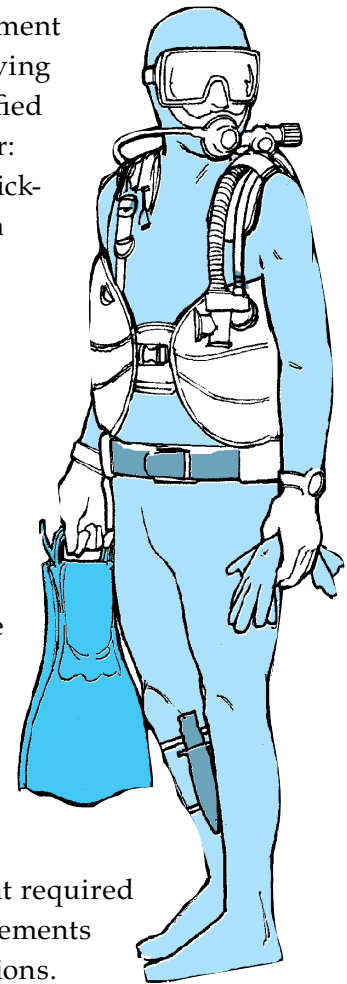

Scuba divers **must** also use any other equipment required by WorkSafeBC. Requirements vary with diving conditions.

Surface-supplied diving

Like all divers, surface-supplied divers **must** know their depth and time limits to ensure safe diving. The following is a schematic of a low-pressure compressed breathing air system:

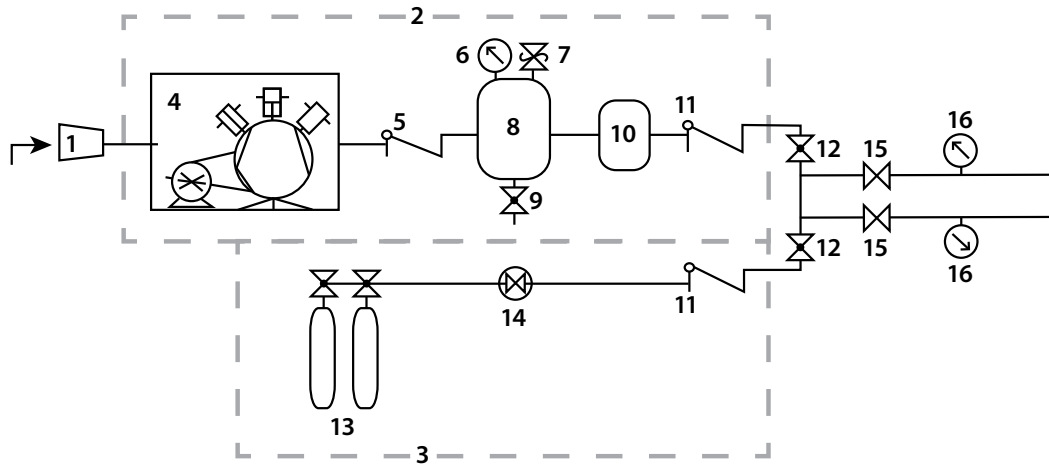

Breathing air system legend and requirements:

1	Compressor intake	Must be located so the breathing medium will not be contaminated by gasoline vapours, engine exhausts, or other impurities.
2	Primary air supply	Consists of the low pressure (LP) compressor, check valve, volume tank with pressure gauge, relief valve and drain cock, air filter, and another check valve.
3	Reserve air supply	Consists of high pressure (HP) cylinders, reducing regulator, and check valve.
4	Low pressure compressor	Supplies air to the volume tank and breathing air filter.
5	Check valve	Is fitted to the volume tank. Air from the LP compressor must be discharged through the check valve into the volume tank.
6	Pressure gauge	Is fitted to the volume tank to monitor pressure within the tank.
7	Relief valve	Is fitted to the volume tank to ensure the tank is not over pressurized.
8	Volume tank	Must have a capacity of at least 100 litres (22 imperial gallons).
9	Drain cock	Is capable of draining any excess moisture.
10	Breathing air filtration system	Consists of at least a water trap, a particulate filter, and a chemical vapour absorbent. Air supplied from a volume tank must be passed through this system.
11	Check valve	Stops the breathing supply set at a higher pressure from back pressuring the opposite breathing supply.
12	Isolation valve	Isolates the primary and reserve air supply from each other.
13	Reserve supply (high pressure air)	Must provide enough breathing mixture to enable the diver to return to the surface and undergo all "in water" decompression.
14	High pressure reducing regulator	Reduces the air pressure from HP to LP.
15	Breathing gas lines	Are attached to each diver's air or mixed gas line and must be fitted with a valve that is: <ul style="list-style-type: none"> • Readily accessible • Guarded against interference • Clearly marked to identify the diver it services • Under the care and control of the diver's supervisor or diver's tender.
16	Pressure gauge	Is fitted to each diver's air or mixed gas line and must indicate the pressure being delivered to the diver. It must be located downstream of the diver's supply valve so that the dial and figures are clearly visible to the diver's tender.

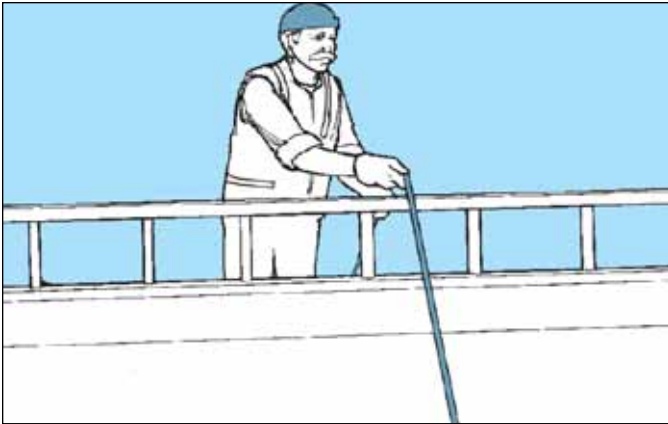

- Surface-supplied divers **must** have a diver's tender.

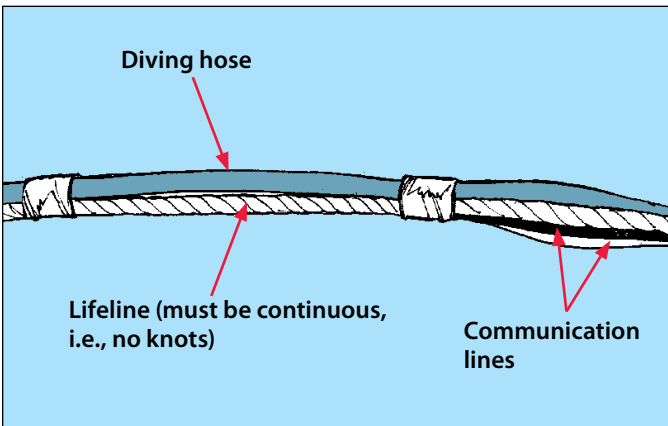

- Surface-supply hoses **must** be a commercially manufactured twisted bundle or attached to lifelines to prevent undue stress on the supply hose or the helmet. Lifelines **must** be 16 millimetres (5/8 inch) in diameter, and made of polypropylene or other equivalent synthetic fibre. Divers **must** use only hoses designed and suitable for surface-supplied diving.

At a minimum, surface-supplied divers **must** use the following gear and equipment:

- Boots designed to fasten securely to the foot
- Weight belt worn outside of all gear and **must** be able to be released to achieve positive buoyancy
- Non-return valves on all surface-supplied diving helmets and masks, which are checked for operation prior to each dive
- Dive compressor equipped with a non-return valve on the upstream side of the compressor
- Diving knife
- Bailout system with enough breathing gas to reach the surface

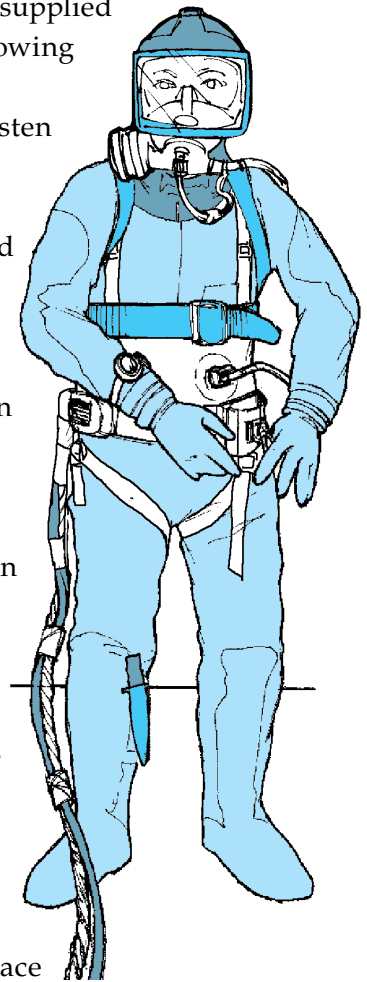

Surface-supplied divers **must** also use any other equipment required by WorkSafeBC. Requirements vary with diving conditions.

Tips from fishermen:

- Make sure flags (dive and alpha) are hoisted and visible.
- Use oversize anchor and chain, and enough chain length to keep the anchor on the bottom for diving operations.
- Always check the diver's reserve and make sure the diver can turn it on.



Because gillnet vessels have small crews, gillnetters should travel in groups of two vessels or more. That way, help is close by if something goes wrong or someone is hurt. Developing a system to check on other vessels is very important and **must** be documented.

When gillnetting for salmon or herring be aware of the following safety procedures and requirements:

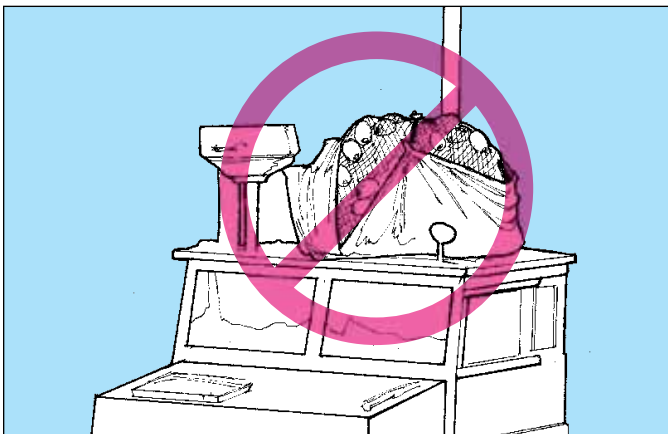

- Don't store nets (or other heavy items) on top of the wheelhouse. This can cause stability problems.

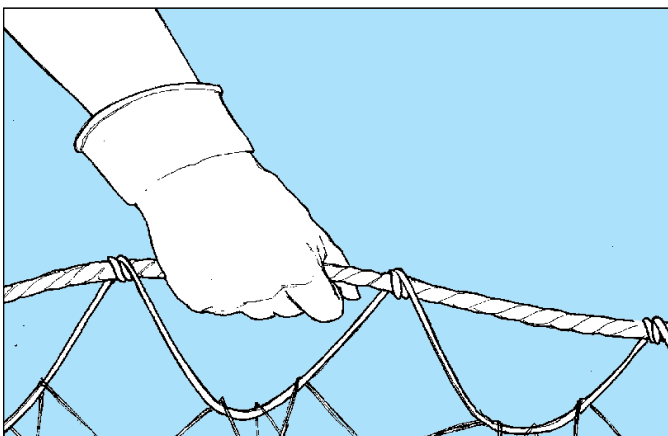

- Use gloves to protect your hands when setting and picking the net or handling fish.

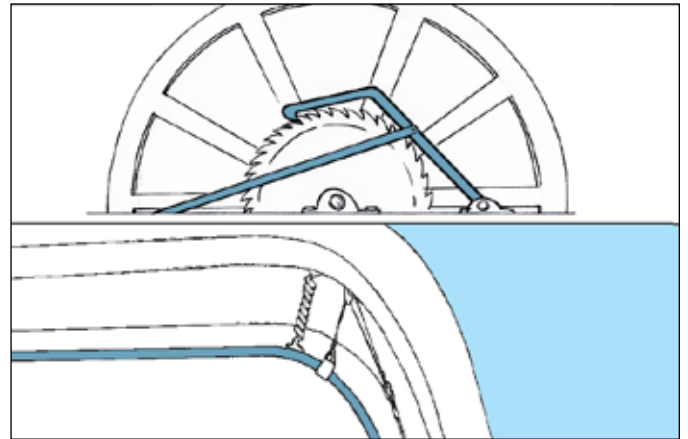

- Both herring and salmon gillnet drums **must** be fitted with a hold-to-run control, a ratchet for picking up under heavy strain, and a brake for keeping control when setting the net. Be sure the hold-to-run control works properly to stop the drum if a crew member becomes entangled in the net or lines being wound around the drum.
- Never use the ratchet and socket system as a brake to stop the drum.
- Always wear a personal flotation device or lifejacket when working on deck.
- Make sure you have a way to get back on the vessel in case you fall overboard. Examples include tying tires to the side of the boat so you can climb onto the vessel from the water, or keeping a rope ladder coiled on the side of the boat with a rope that you can pull to deploy it.

When gillnetting for salmon, consider the following safety procedures and requirements:



- When setting, keep clear of the net. Don't try to clear snags while the vessel is underway. Use caution when working around weedline beckets.

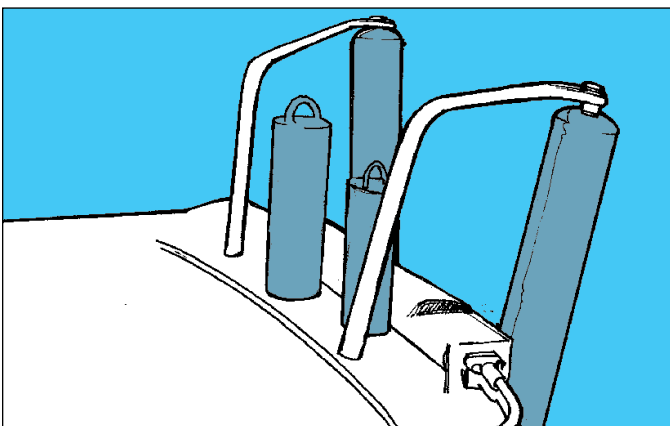

- Prevent pinrollers from lifting. Pinrollers **must** be designed and maintained to prevent them from lifting. If a pinroller lifts, the pin—or the net—can strike the crew.
- Make sure you have installed guardrails that will prevent falls into the water.
- Be aware of spiny fish, especially rockfish and ratfish, when picking the net.
- Stay in touch with other vessels often to ensure that they know you are not in trouble.

When gillnetting for herring, consider the following safety procedures and requirements:

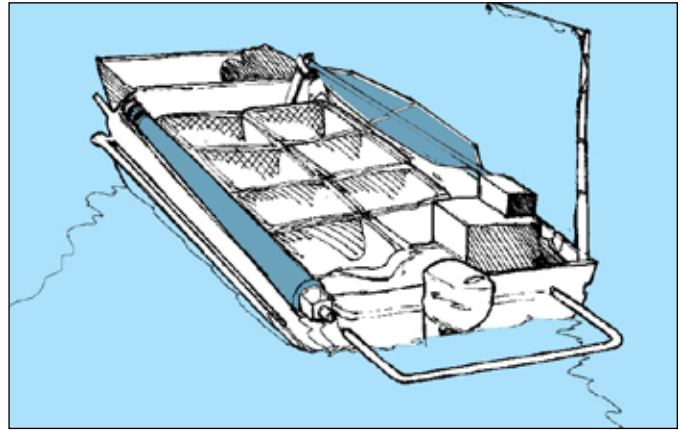

- Work areas on herring skiffs and punts **must** be arranged so crew members do not contact moving equipment such as beater bars and live rollers.

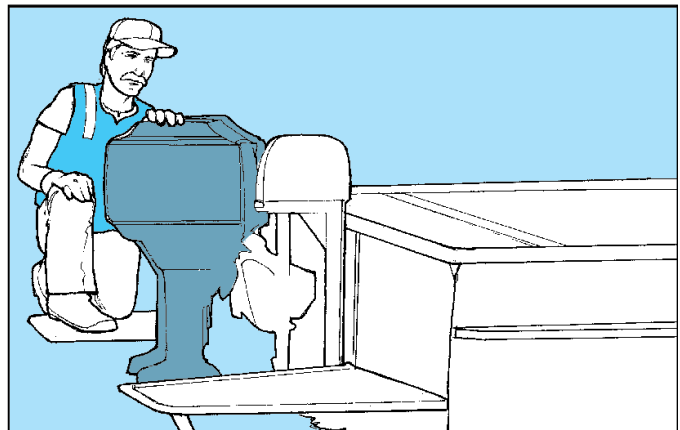

- Crew members **must** be taught how to safely clear fouled propellers on a herring skiff. Using standing grids, hoists, or tie-off lines can make clearing propellers safer.

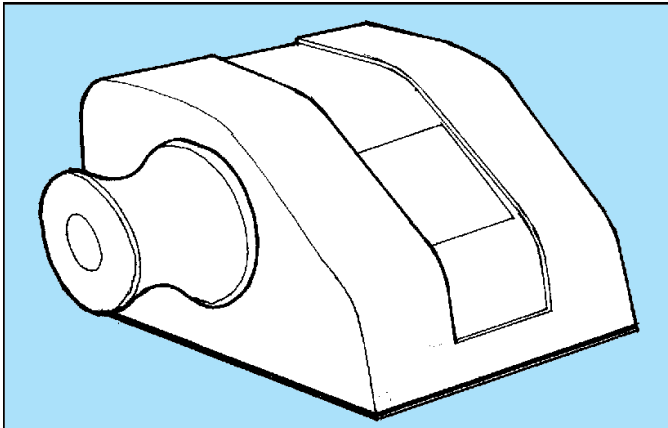

- Herring skiffs and punts **must** have a mechanical means, such as a live roller or an anchor winch, for hauling net anchors.

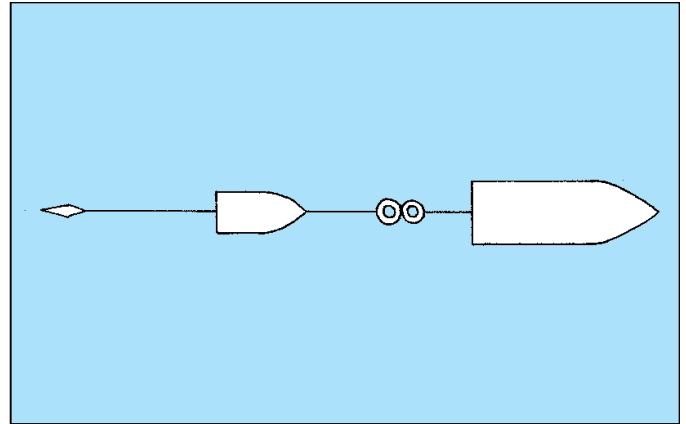

- When towing a skiff or punt, the master of the vessel **must** use appropriate rigging and develop safe towing procedures for all weather conditions. These procedures **must** cover how to self-bail the skiff or punt, how to use the tow line shock absorbers, and how to use sea anchors to prevent sheering and overtaking.
- When shaking the net, crew members need to stay clear of the beater bar, live roller, and hot wheels.
- When hauling the net on board the skiff, consider using a powered hauling device. This will reduce the chances of back strain or injury.
- When towing, always use the correct towing lights on both the towing vessel and the skiff to avoid collisions with other vessels.
- To reduce the chance of being overloaded and swamped, deliver the catch often.
- When travelling near a fishing fleet, a slower speed can reduce wake and prevent the swamping of other vessels.



- Never stand or walk under a suspended load.
- Never pass a boom—loaded or unloaded—over a crew member, if possible.
- Keep the load as low to the deck as possible:
 - To avoid the risk of lifting the load over crew members
 - To keep it from hitting a crew member

Tips from fishermen:



Have a re-boarding plan if you are working alone.

Use a positive type of drum brake to quickly stop the drum in any of the following situations:

- A backlash occurs
- The drum speeds up uncontrollably while setting in a heavy swell
- Use a hand-held handle and hook to take spiny fish like rockfish out of the net.
- Avoid travelling at night if possible.
- Be aware of fatigue issues.

Longline

The following safety steps and requirements are specific to working with longline gear:

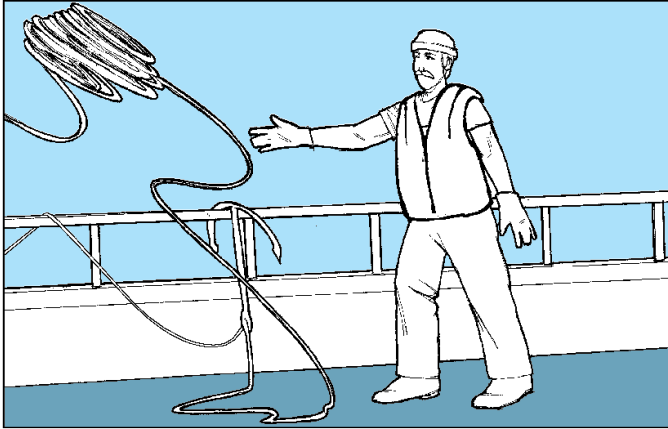

- When setting anchors and buoy lines, stay clear of the anchor itself and the bights of all lines.

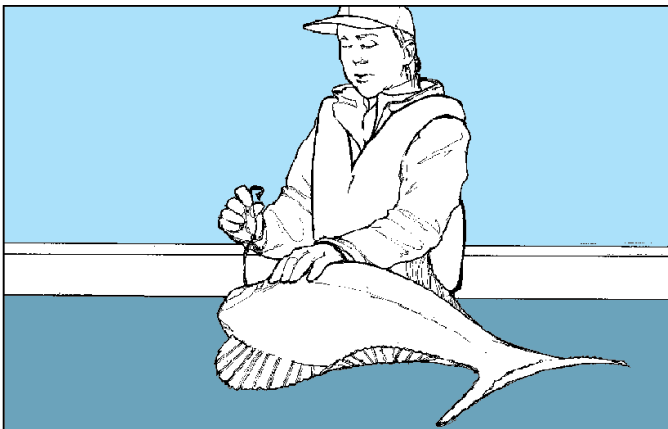

- Try to remove all hooks or parts of hooks from fish before dressing them or putting them in the hold. This helps reduce injuries to the crew and fish processors.

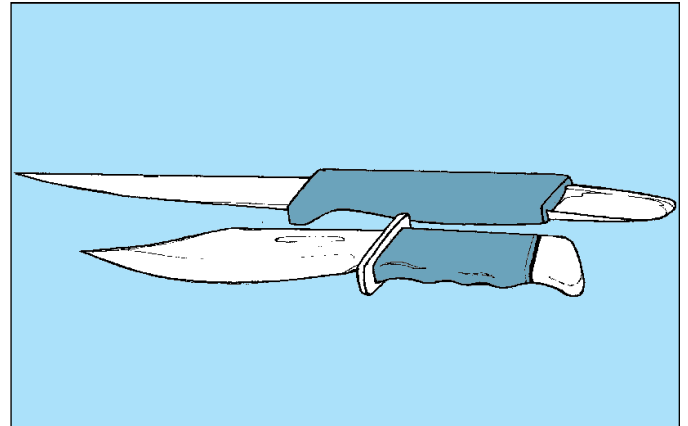

- Each setting and hauling station **must** have a knife to cut gear. Being able to cut gear is crucial if a crew member gets caught in the gear or is snagged by a hook.

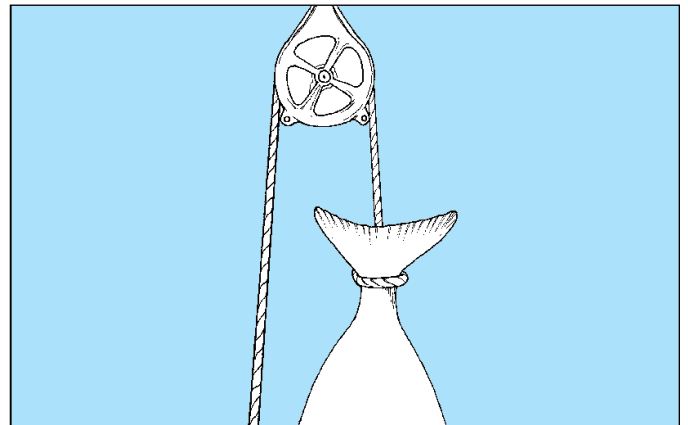

- When lifting a large fish from the deck or hold, use a hoist. A hoist **must** be used if a crew member could be injured trying to lift a fish.
- When using conventional or snap-on gear, stay clear of the ground line and hooks to avoid getting snagged. (Drums and automated systems using longlines and hooks **must** be guarded to prevent crew members from being snagged by hooks).
- When throwing the anchor over, be aware of slipping and falling. Make sure your clothing won't catch in the anchor.

- When setting your anchor at the end of the line, stay clear of the buoy line. If you get caught in the line, you could get pulled over. Always wear a personal flotation device and carry an easily accessible knife.
- When gaffing large fish, there's a real danger of getting pulled overboard, or suffering a serious back injury. When gaffing, try to bring the fish up with the roll. For very large fish, ask for help in bringing them over. Hold the gaff properly, so the stem can turn freely without twisting your wrist.
- When chopping bait, use a sharp knife. If you wear gloves, make sure they are close-fitting to allow good movement. Tilt the blade away from you when cutting. If you do get cut, take time out for first aid treatment – fish poisoning can be very serious.

Tips from fishermen:



- Watch the weather, and pay attention to forecasts.
- Keep all rope coiled and secured with no loose ends, especially unused lengths of rope.
- Use “C” links to connect strings of longline gear, anchors, and flags to prevent gear from getting entangled.
- Mark longline gear with coloured tape or twine to indicate when you are coming to the end of a string or are near the anchor.
- Keep your wrists straight when working, especially when dressing and scraping fish. Take breaks to stretch wrists, back, and other stressed muscles and joints.
- Use a positive type of drum brake to quickly stop the drum in any of the following situations:
 - A backlash occurs
 - The drum speeds up uncontrollably while setting in a heavy swell

Packing

Fatigue is a major hazard for packer crew. Tight delivery schedules mean the crew often works long hours with few breaks. Because accidents are more likely when the crew is tired, plan crew rotations so everyone gets enough rest.

Safety steps and requirements for packing include the following:

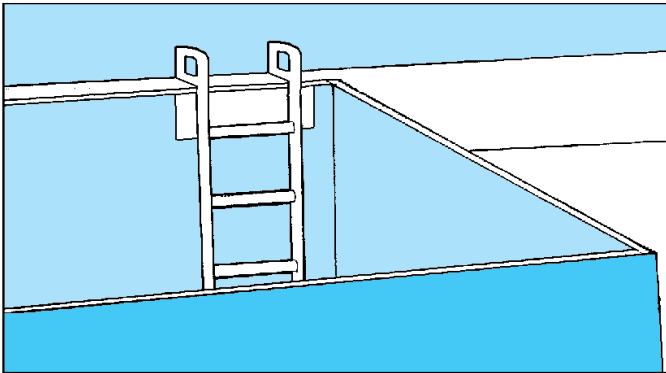

- For fish holds, use ladders that attach securely to the hold. If you need to use portable ladders, ensure they are tied off securely. Home-built ladders **must** comply with Part 13 of the Occupational Health and Safety Regulation.

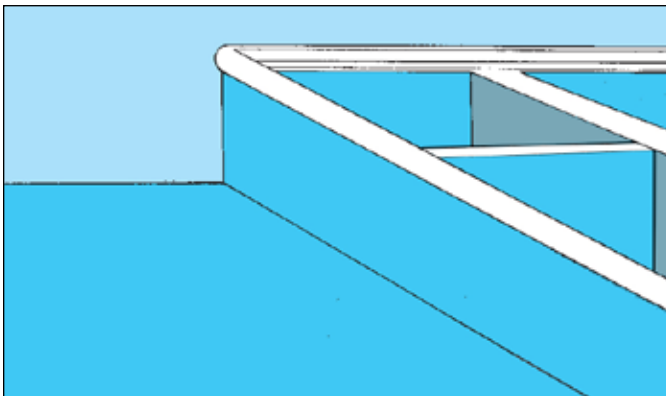

- Be aware of open tanks. Cover tanks after delivering or unloading fish. Secure them in heavy weather to keep water from sloshing out of them. Water loss from the tanks can lead to free surface effect and related stability problems.

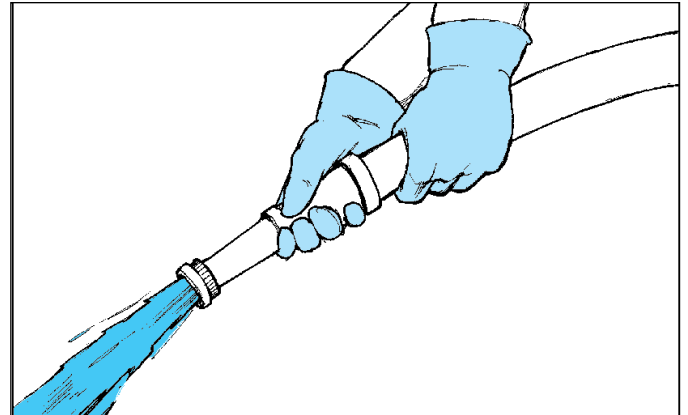

- Regularly hose down decks and other areas to remove fish slime. This will help reduce slips, trips, and falls.

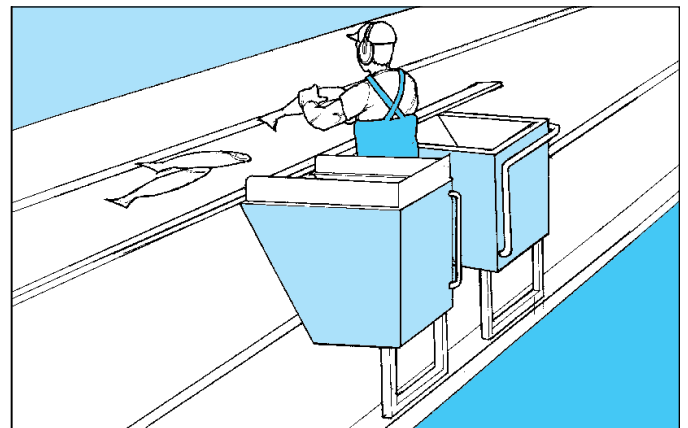

- Make sure all workers know grading table procedures. This is especially important for crew from other vessels who may help in grading.

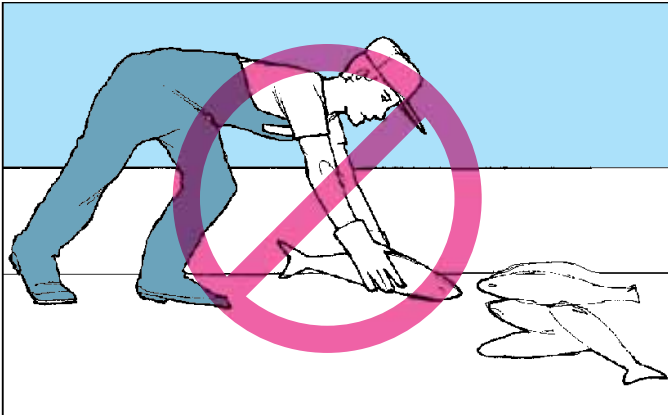

- Develop safe work procedures for pitching fish. Good posture and efficient organization of work areas can help prevent back, neck, and arm strains, and other injuries caused by throwing and handling fish.

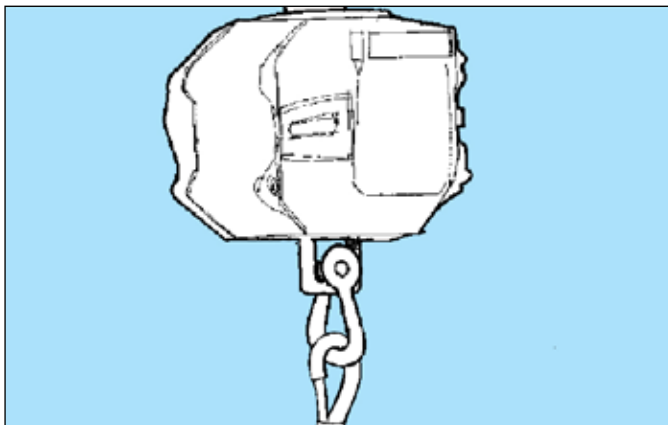

- Use a rated shackle or hook with a safety latch to attach the scale to the brailer. An open hook can slip, especially in heavy swells, causing the hook or the bag to hit crew members.

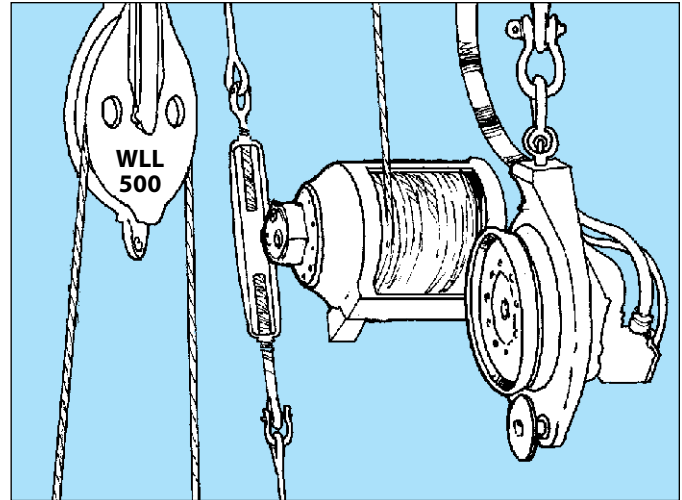

- Inspect all rigging gear. Chains, slings, hoists, turnbuckles, derricks, blocks, and anchor gear **must** be inspected prior to each use and kept in safe working order. Since chains are manufactured for different purposes, make sure the chain is designed for its intended use. Chains used for hoisting **must** be grade 80 or better.
- Keep a rigging inventory for maintenance and replacement purposes.
- Never exceed the working load limit—the amount of weight that your boom, rigging, shackles, blocks, and other equipment can handle safely. Lifting loads that weigh more than the rated capacity can cause equipment failure, which can lead to accidents and injury.

Rigging requirements are set out in Part 15 of the Occupational Health and Safety Regulation. In addition, see the information on hoists and rigging in the “Safety Procedures” tabbed section.

-
- Keep stability documentation—describing the vessel’s maximum load in various conditions—available on the vessel.

Other safety steps for packing include the following:

- When taking fish, load the vessel so that list is eliminated, and keep the vessel trimmed.
- After taking fish, secure the deck, and make sure hatch covers are in place and secured immediately after the hold is loaded. Securely stow gear, lines, and equipment.
- If fish are loaded on deck, make sure the load is secured and in compliance with stability documentation.
- It’s good practice to lower the boom when underway.

- When towing barges or other vessels, display the correct lights and signals as required by Transport Canada’s Collision Regulations.

Tips from fishermen:

- Check all the valves, hatches, strongbacks, rigging, and winch cables.
- Use the tanks in proper loading configurations to optimize stability.
- Make sure the boat crew and the vessel being offloaded are all communicating.
- Use standard hand signals.
- Don’t overload the brailers or tubs.



Seine

Seining, including skiff work and beach operations, creates safety hazards. All seine crew **should** know their jobs and how to protect themselves from hazards.

Safety steps and requirements for seine crew include the following:

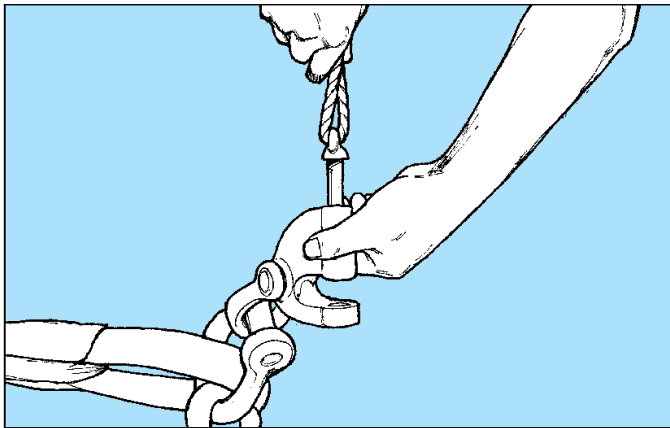

- Inspect all end-of-net hardware for sticking blondies (quick-release shackles), worn straps, loose shackle pins, and other defects. Broken hardware can create unexpected hazards such as lines whipping and/or breaking, or equipment striking the crew.

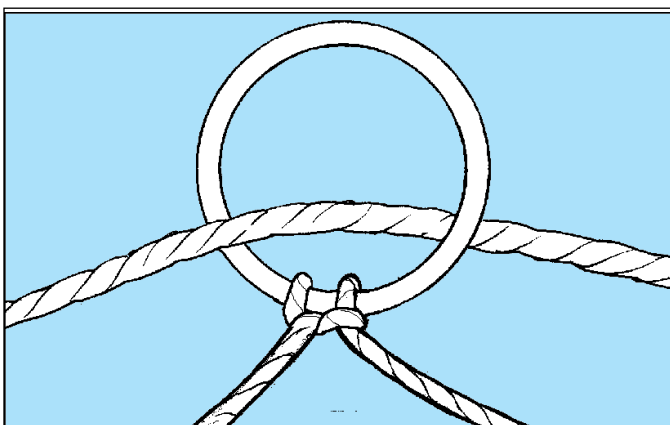

- Purse rings on seine nets **must** be secured to the middle of the ring strap. This prevents rings from falling and hitting crew when back hauling the net through the power block.

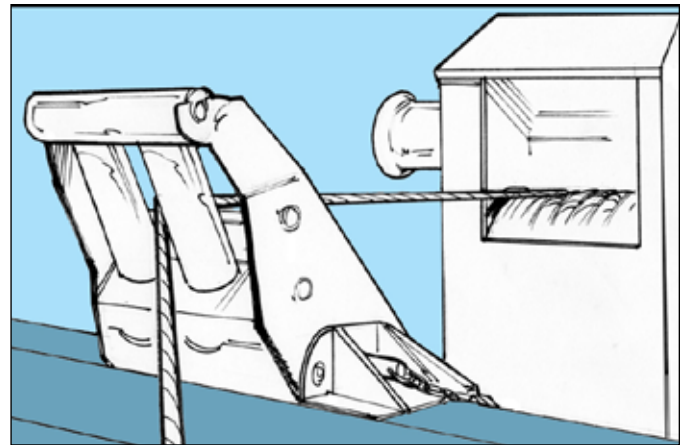

- Pursing winches and davit leads **must** be positioned to ensure proper spooling of the line onto the winch drum. If the line isn't spooled properly—for example, if it spools only on one side of the drum—it is more likely to backlash when being let out. When gear spools properly, it eliminates the need for crew members to direct the line, and increases the life of the line by reducing damage to it.

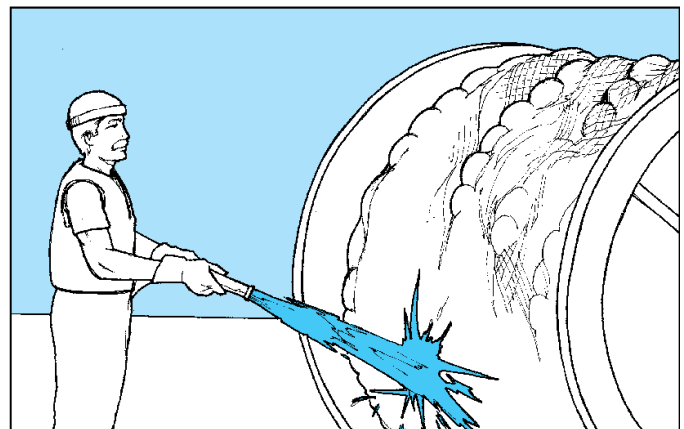

- Watch for backlashes when setting the net. When possible, clear backlashes with a deck hose instead of a broom handle or a deck brush. Using a hose keeps you well clear of the net.

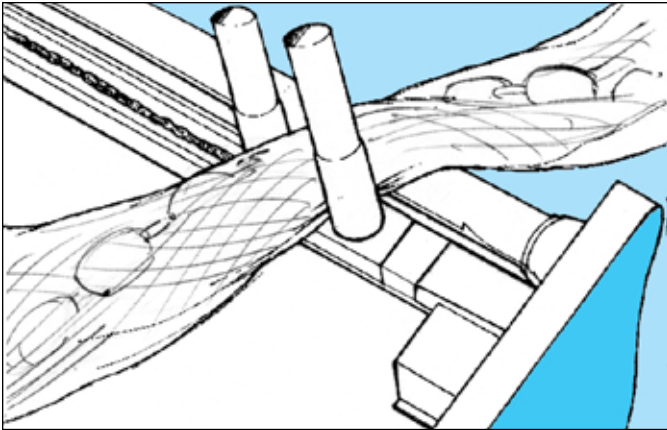

- Crew members **must** stay clear of stern spooling gear while it is operating. A major hazard is getting feet caught between the spooling roller cradle and the side of the boat. Add stop blocks to limit spooler travel to rails.

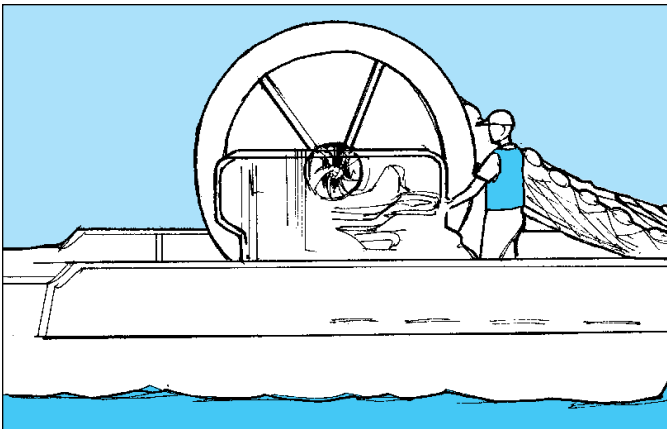

- The drum operator **must not** leave the controls while the drum is turning. Never attempt to remove the tow line hook or tuck the strap while the drum is turning. The drum operator needs to be able to stop the drum quickly in case of emergency. Consider hold-to-run controls.

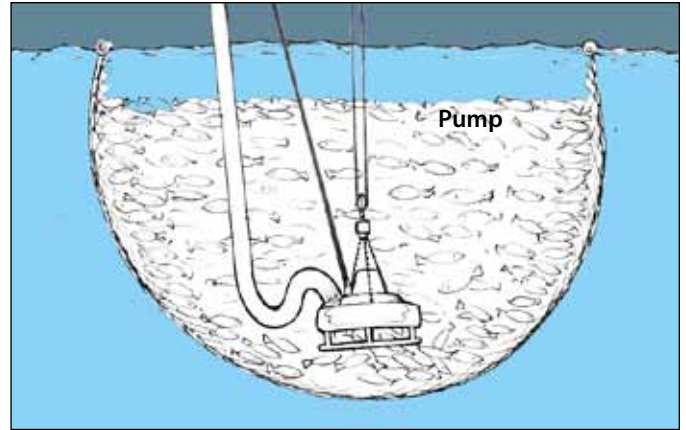

- When seining for herring or sardines, pumping gear **must** be able to pump fish from the bottom of the bunt while the net is set. Dying fish create deadweight that can cause stability problems. Always carry enough extensions to pump the bunt of large sets.

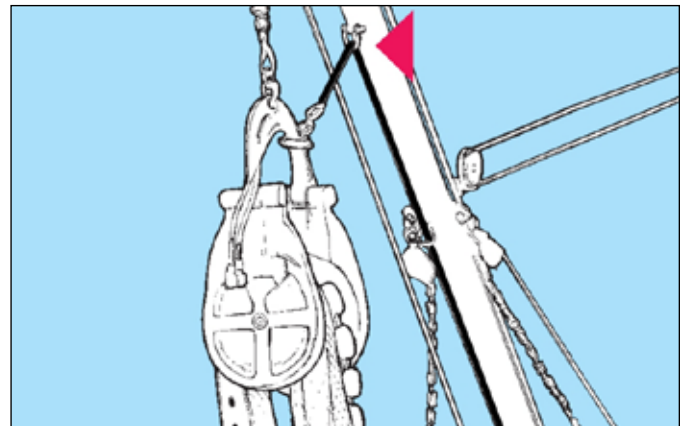

- Power blocks **must** be attached to an effective safety line when hanging above the deck.

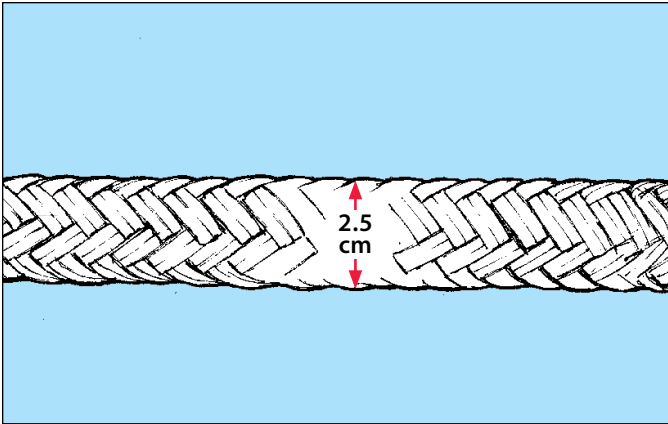

- Power block haul lines **must** have a diameter of at least 2.5 centimetres (1 inch) of double braid nylon or the equivalent. The capacity of the line **must** be rated to safely secure power blocks. Inspect rope regularly, looking for wear, cuts, variations in sizes, and discolouration.

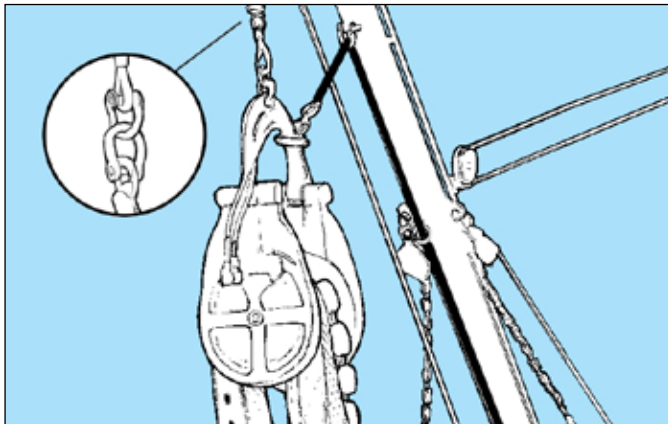

- Haul lines **must** be shackled to the power block. Use adequate shackles and regularly check their condition.

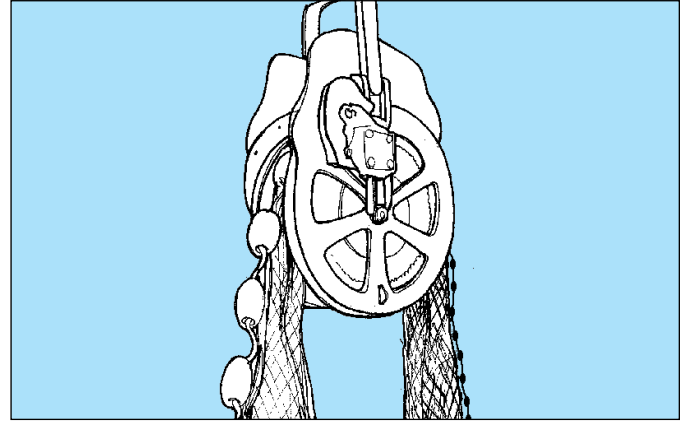

- When working on or fleeting the seine, power block operators **should** watch for and warn the crew of lead lines dropping from the block. Wear a hard hat whenever there is an overhead hazard.

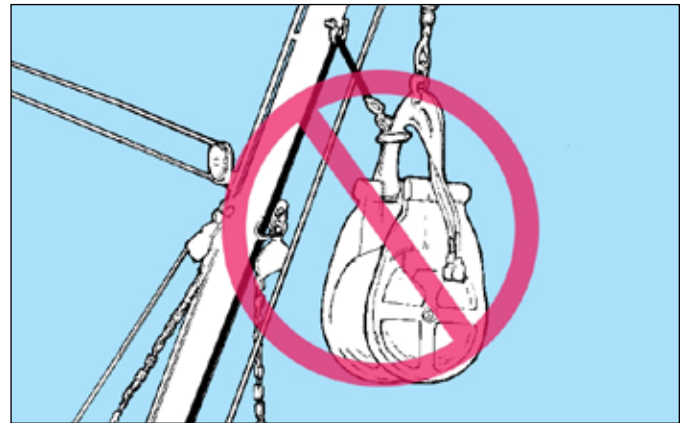

- Don't leave power blocks or heavy equipment hanging in the rigging when not in use. If a line snaps, gear or equipment could come crashing down on the crew.

Safety steps and requirements for working on seine skiffs include the following:



- Crew **must** wear a life jacket or personal flotation device in a skiff.

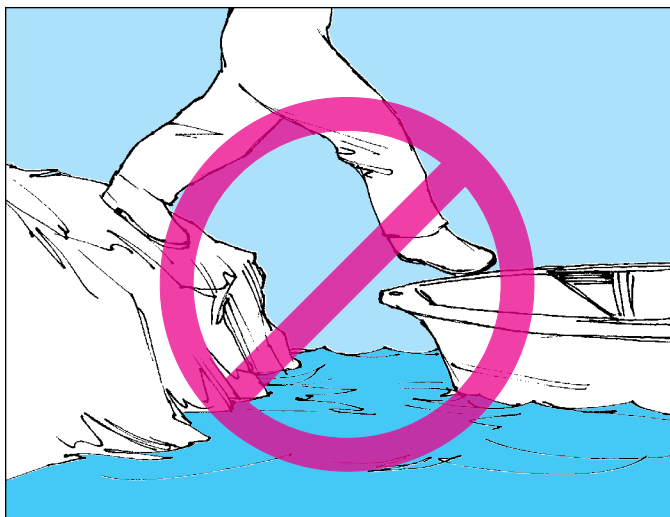

- Avoid jumping into a skiff. It's too easy to lose your balance, slip, or fall.

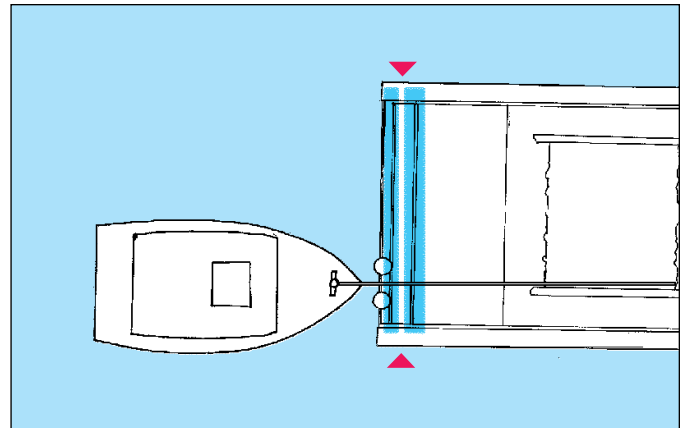

- When climbing in or out of a skiff, stay clear of the pinch points between the skiff and the main vessel.

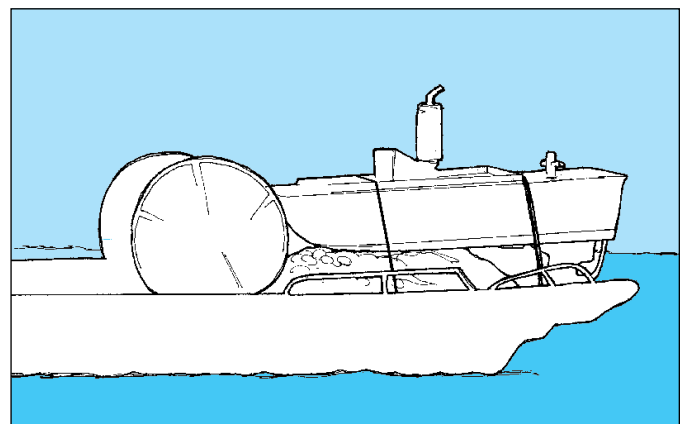

- If a skiff is being carried on deck, secure it so it won't shift and hit crew members, damage equipment, or cause stability problems. Secure the skiff with a nylon strap that can be easily cut if necessary. Ensure the painter line runs under the drum while the skiff is secured or being towed.
- When skiff crew are being towed in the skiff, the master **must** make sure effective communication exists between the main vessel and the skiff.

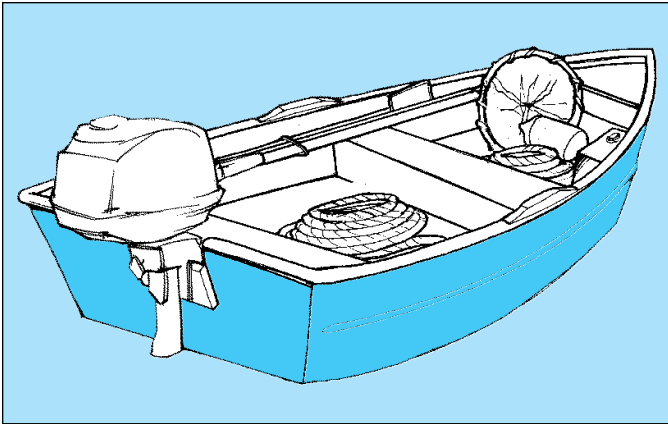

- Keep oar locks and oars in the dead skiff and organize and safely stow all gear.

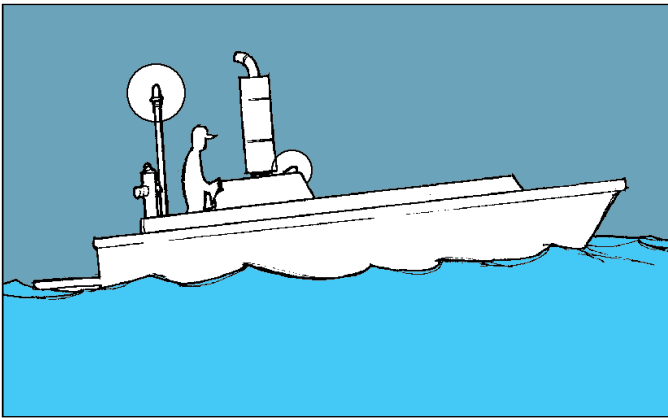

- Make sure the power skiff has proper navigation lights for night use.



- Don't smoke around the gas tank of a skiff with a gas-powered outboard. Be aware that sparks from welding torches or open batteries could ignite gas fumes, resulting in a fire or explosion.

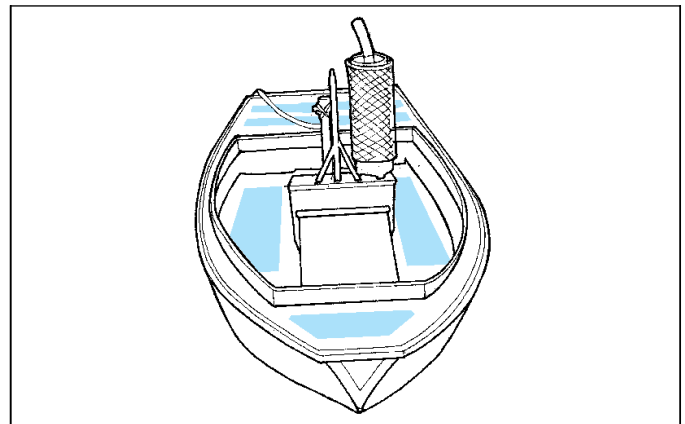

- Decks and floors **must** be non-skid, where practical, and the rails and sides of the skiff **must** be free of snags that can catch the net.

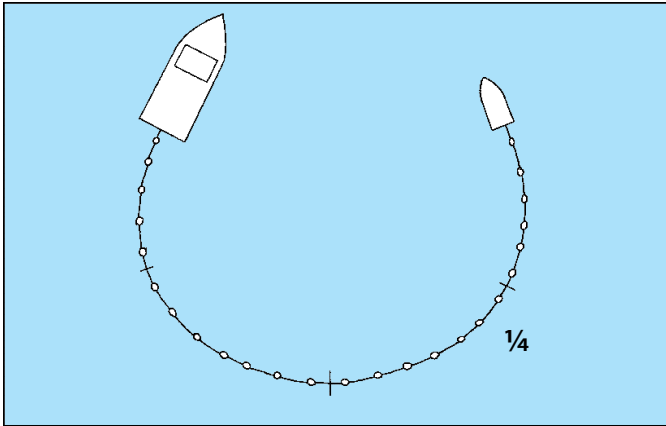

- Skiffs **must** be operated so that the skiff won't capsize from a backlash in the net. For example, when setting with a power skiff, make sure at least one-quarter of the net is in the water to act as a shock absorber before turning the skiff to tow.

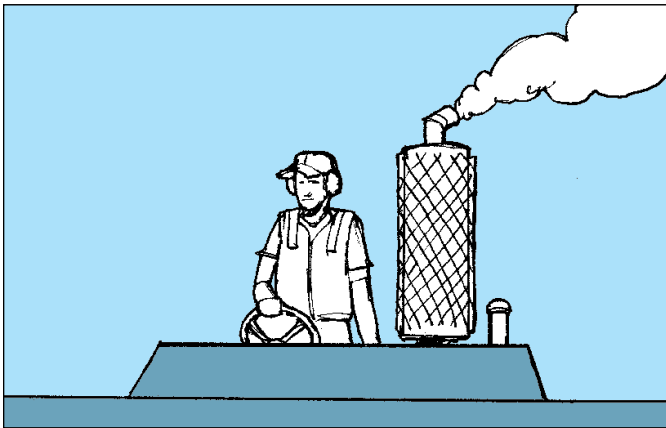

- In a power skiff, the exhaust system **must** be shielded to prevent burns and **must** direct exhaust away from the crew.

Other seining safety steps

When towing the seine:

- Use a good, strong strap to secure the tow end of the seine. If the strap breaks, the tow hook could come flying back aboard.

When closing up:

- Stay clear of the running line. If the line snaps, it could cause serious injury if it strikes crew.

After closing up:

- Avoid taking the skiff under a tensioned tow line.
- Use coordination and care to get the second person back aboard the seine vessel safely. Competent skiff handling and timing with the swell are essential.

When using the stern ramp:

- Keep clear of the spooling gear and the pinch point between the ramp and the bulwarks.

At the end of the set:

- Stow the tow hook so it can't get caught in the net during the next set.

Beachline operations

Beachline operations can be very dangerous. Each tie-up presents its own set of potential hazards, which will vary according to tide and terrain conditions, and setting procedures. For example, when working with very strong tides, there is always a danger that the beachline will break. Other hazards may include slipping or tripping on rocks, falling from heights, or getting struck by a beachline.

Because of the potential for injury, crew who tie up to the beach **must** be trained and adequately supervised. Never put a crew member without experience or training on the beach. Beach crew **must** know how to:

- Assess tie-ups
- Communicate with the skiff (e.g., use hand and sound signals)
- Attach beachline straps
- Tie and untie proper knots
- Safely cut lines or straps

Beach crew **must** wear gloves to prevent cuts from barnacles, and appropriate boots to prevent slipping on seaweed or slippery rocks. Beach crew **must** carry a knife to cut the beachline or the strap, if necessary.

Other safety steps for the beach crew

When going ashore:

- Plan ahead. Scout the shoreline for good tie-up sites – and how you’ll get to them.
- Partially lower the stern ramp, if the vessel has one, so the beach crew can get into the skiff more easily.
- Ensure the skiff is clear of the seine boat before throwing the sea anchor into the water. Otherwise, if the painter doesn’t release immediately, the seine could be set over the skiff and crew.
- Getting the beach person to shore often requires proper skiff handling and timing with the swell.
- Avoid carrying a beachline over your shoulder. If the net backlashes, you could be pulled back and fall.
- Use knots that can handle the strain, if you have to join two lengths of beachline. For example, if the extension has no spliced eye, use two bowline knots or a double sheet bend (cat’s paw.) Or use a double cat’s paw to tie the plain end of the main beachline to the eyed end of the extension.

When tying up:

- Avoid tying the knot directly to a tree, where practical. Tie it to a strap. Cutting the strap is generally safer than cutting the beachline.
- Don’t use straps left on trees from previous years. They may be rotten and more likely to break.

- Make sure you have enough slack in the line to give you time to tie the knot. Beachlines often need to be tied quickly, but don’t rush. Working too quickly invites accidents.
- Never put your hand through a loop when forming the next knot. If the line tightens, you could hurt your hand or lose a finger in the bight.
- Stay out of the hazard area between the tie-up point and the vessel. And always use safe knots with enough length to protect yourself from potential beachline whip.

When releasing the beach knot:

- Make sure you are clear of the beachline. Keep the line ahead of you.
- Reduce the tension on the running line, when appropriate. The master **should** coordinate with the winch operator to minimize the tension on the running line when the beach person is releasing the beach knot.

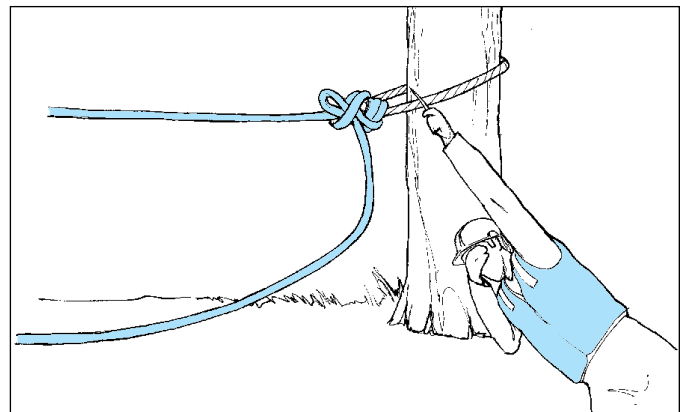

- Protect yourself when cutting a strap or beachline:
 - Keep your head, body, legs, and feet away from where the line will be cut.
 - Cover or close your eyes to protect them from pieces of flying rope.

Tying to a tree

If you have to tie a beachline directly to a tree, make sure that the first wrap around the trunk is going in the right direction – that is, so that the last wrap will fly off the tree away from you. A line that is wrapped around the tree in the wrong direction can kill you.

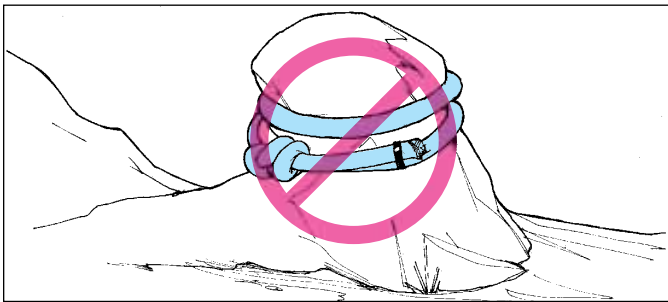

Never wrap a strap twice around a rock or stump. It is dangerous to cut a “double strap” – the strap may whip and cause serious injury.

Working in the dark

Fishing quotas have changed the fishery, and night fishing is not as prevalent as it once was. If beach crew do have to tie up in the dark, proper lighting is required. It is not safe for beach crew to use only a flashlight to guide themselves over the shore. It may be steep, rocky, or covered with seaweed. Beachline operations **must not** be done unless the following steps are followed:

- All crew are trained in “dark set” procedures.
- The seine boat can provide enough light to the work area.
- Skiff crew wear high-visibility clothing as well as the required lifejacket or personal flotation device.
- Effective communication (using hand, light, or air-horn signals) is in place between the beach crew and the seine boat.

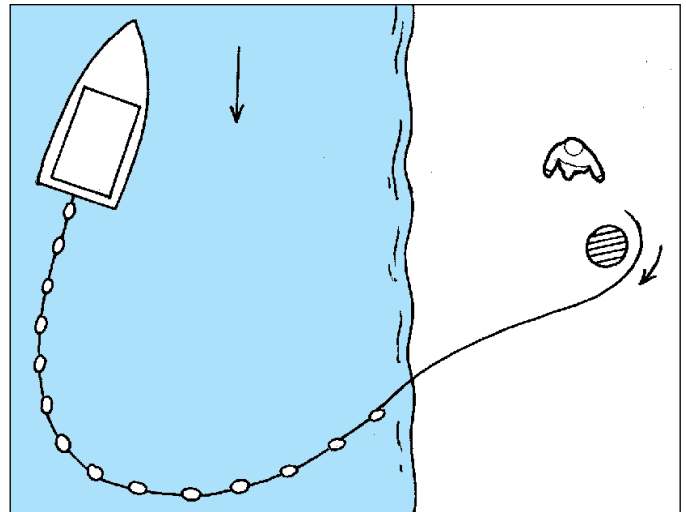

For a right-hand or starboard-side set

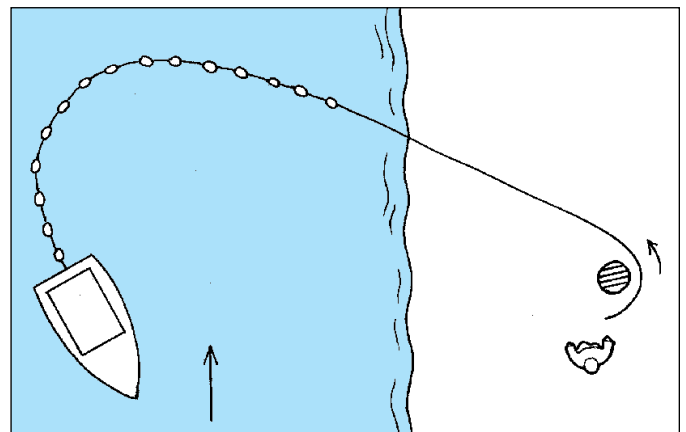

For a left-hand or port-side set

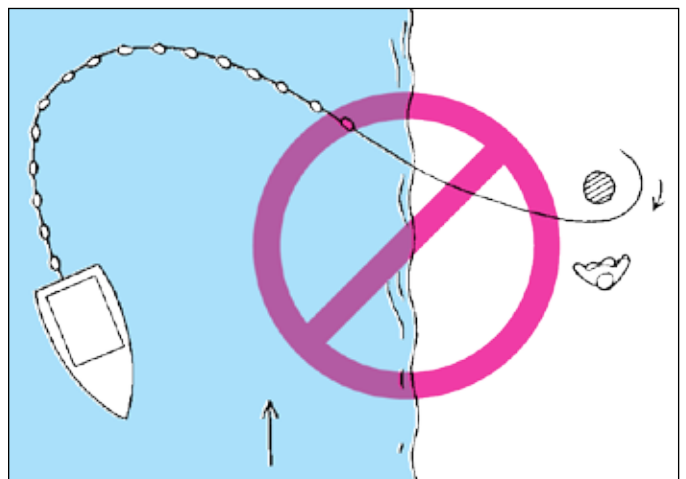

Wrong way to tie to a tree

If it's necessary to tie to a tree, choose the right knot for different variables such as tide conditions, vessel towing power, and the location of the tie-up site. The following is an example of a basic knot used for tying to a tree.

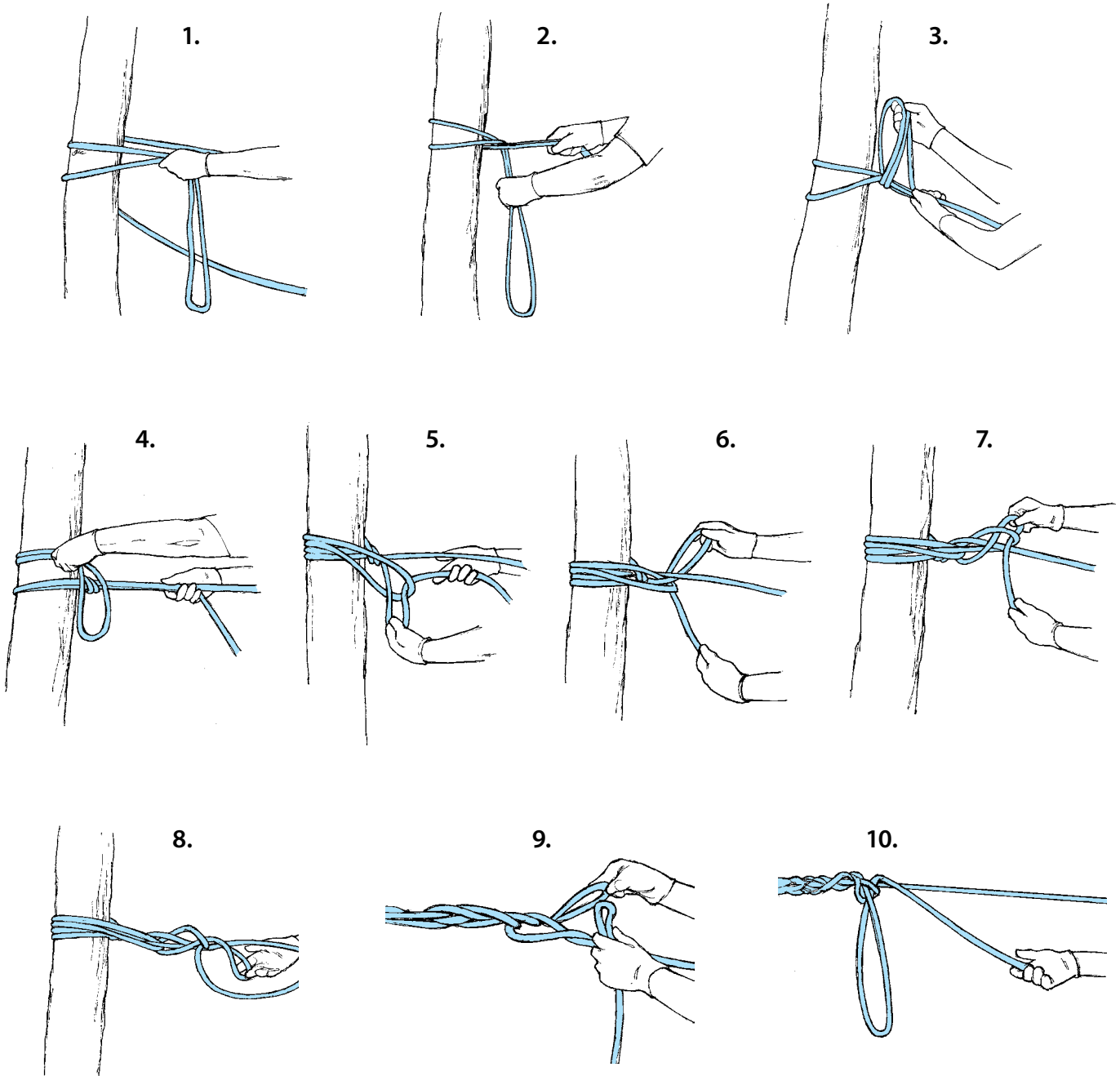

-
- When using a strap for a large tree, stump, or rock, make sure the strap is strong enough to handle the strong forces during the set. Keep a wide selection of straps in the skiff that will fit different sizes of trees and rocks. The following is an example of how to tie a safe, all-purpose strap knot.

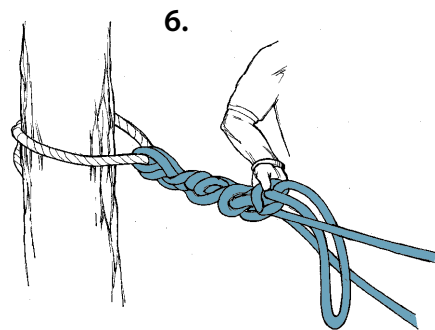
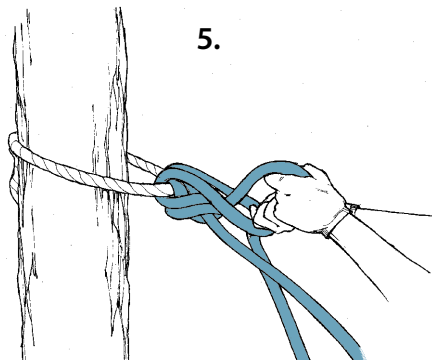
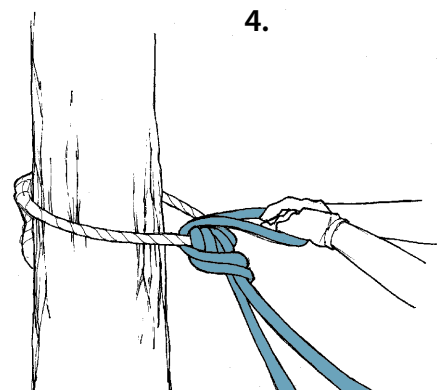
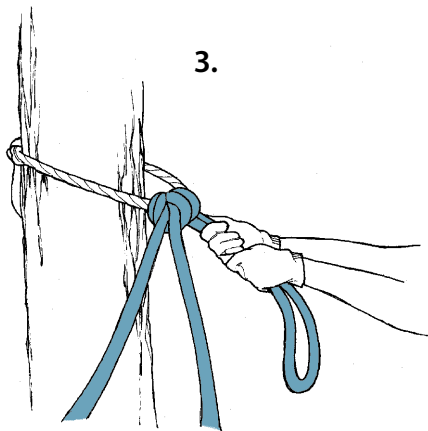
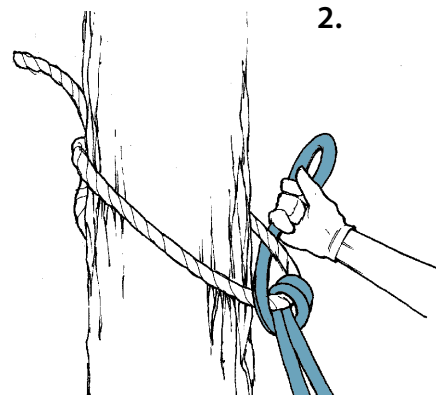
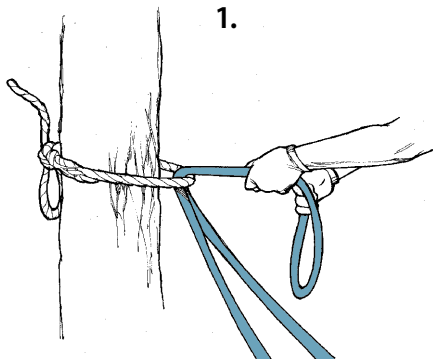

Brailing procedures

When brailing, consider your vessel's limitations, weather and sea conditions, and the weight in your net. Always err on the side of safety when judging how much is in your net.

Like any activity in commercial fishing, brailing has its hazards. Stay clear of the brailer when it's swinging. Avoid the pinch points between the brailer and the vessel, and between the handle and the drum stand.



A typical crew set-up is one person on the brailer handle, one person on the rail to assist, one person on the brailer trip wire, and one at the controls.

Make sure all crew know the proper brailing procedures for your vessel.

Typical brailing procedures

1. Ensure the brailer and all the lifting apparatus are designed and maintained in a condition capable of withstanding the lifts.
2. With the corks suspended from the brailing boom, drum up the net removing all the slack from the web. Make sure the spooling gear is in the correct position on the setting side.
3. Make sure the lead line is out of the water.
4. Strap the net at the stern roller. Hook the boom tip single fall into the strap and position it around the stern roller.
5. Back off the drum to take the weight on the strap, and raise the single fall to create a pocket for brailing amidships.
6. Dry up the slack web and secure it to the rail. If using a hydraulic roller, be sure crew are clear before turning the roller so there is no possibility of injury. If using a strap and single fall, make sure weight is not left on the boom. Tie the strap to the rail to keep a lower centre of gravity.
7. Strap the web off at the rail from the boom end of the single fall. Lower the single fall while drumming in excess slack web to keep a low centre of gravity, while moving the spoolers to the opposite side of the vessel to help maintain an even keel.
8. Brail fish. At a minimum, masters **must** establish safe drying up procedures that cover: communicating on deck; coordinating crew activities; securing the net; hoisting fleets; and jettisoning the set if the vessel is endangered.
9. When brailing is done, stow and secure the brailer and replace the hatch covers.
10. Release the corks and web. When all crew are clear of possible entanglement, give the "all clear" and return all the web and corks to the water.
11. Release the net end and drum the net in.

Tips from fishermen:

- Make sure you have a procedure in case you have an emergency release of a set.
- Don't bury the tow strap when drumming in the net.
- Make sure all crew know how to shut off the hydraulics in an emergency.
- Always wake up the skipper if unsure of anything while on the watch.
- Make sure all controls are identified as to their use.
- Close watertight doors and portholes when drying up to prevent down-flooding.
- Don't leave heavy weights suspended from booms. Strap the seine to a cleat on deck to relieve weight from the boom.
- When fishing is over, lower the boom and lift the davits inboard.



Trap

A key concern is overloading the vessel with too many traps. Several vessels have capsized because of too much weight or shifting weight. Safety steps and requirements for trap fishing include the following:

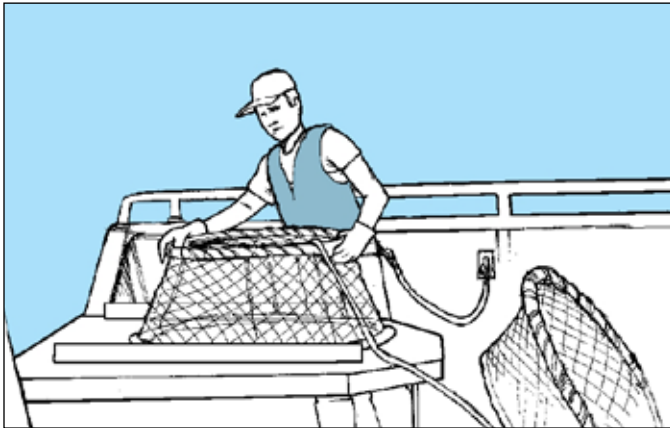

- Crew working on the stern, where they are snapping black cod traps to the ground line, **must** wear a safety belt or a harness and be secured to a lifeline.

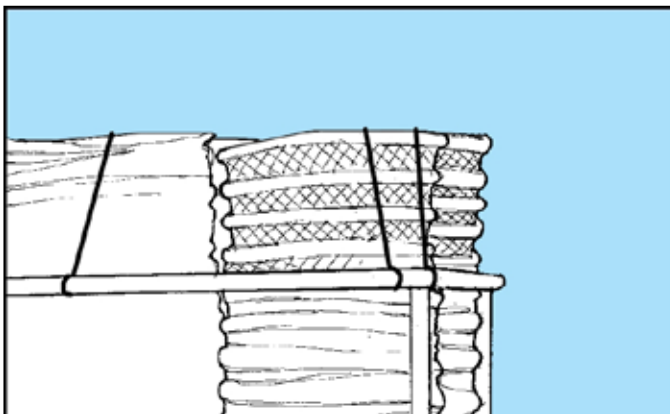

- Make sure adequate vessel stability is maintained by properly loading and securing traps prior to travel, and by ensuring the weight and placement of traps on board meets stability requirements for the vessel.

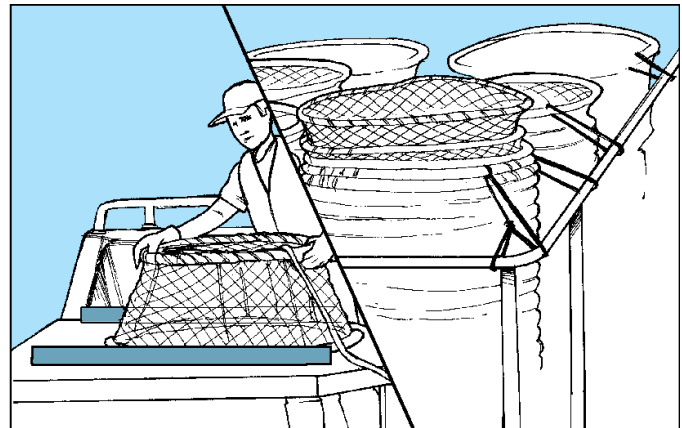

- Secure the traps. Traps **must** be secured to stop them from swinging or moving during setting and hauling, and while the vessel is underway.
- Attach two safety lines to the bait when using the single fall to transfer it from the hold to the stern. That way the crew can guide it and stop it from swinging.
- Ensure the crew stays out of the bight of lines when setting and hauling traps.
- Be very careful when untangling the trap line if it becomes twisted around the ground line during hauling. Untangle the line slowly, keeping enough control so that the snap does not whip free and strike you.
- Always have at least two crew members position large traps for dumping. A trap full of fish can weigh 180–225 kilograms (400–500 pounds), and a crew member who tries to position a full trap alone could suffer serious strains or injury of the back or muscles.
- Try to make sure the deck has a flat, non-skid, level surface that is not obstructed by angle irons and other tripping hazards.

Tips from fishermen:

- Keep hauler sheaves in good shape to avoid violent slipping, especially while coiling down.
- Avoid pre-building too many traps in rough weather, as these can launch themselves in a rolling boat.
- Stay out of the bight and keep your coil neat.
- Use your legs with the weight centred close to the middle of your body to assist in lifting traps onto boat when hauling in the string of gear.
- Keep knives handy at all fishing stations.



Trawl

Each type of trawling operation has its own particular hazards. Thoroughly inspect your operation for possible hazards that could injure crew. Safety steps and requirements for trawling operations include the following:

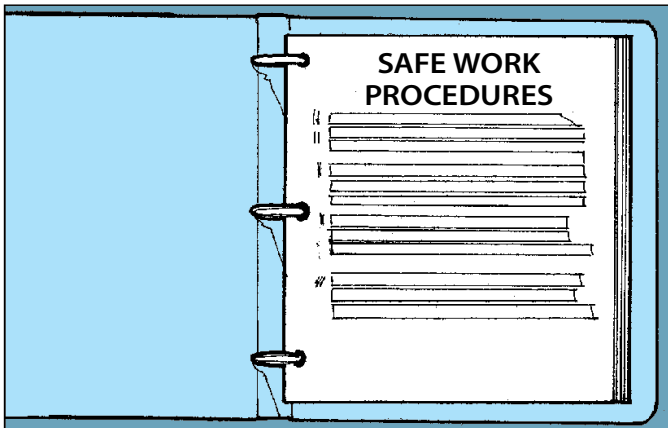

- The master **must** put in place safe work procedures for shooting and hauling trawls, and for fleeting the net.

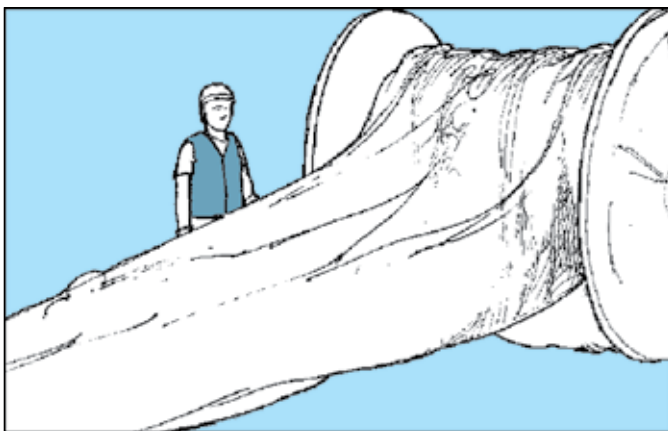

- When shooting the trawl, the crew **must** stay clear of the net once the cod end is overboard. That way, they are less likely to get caught in the net.

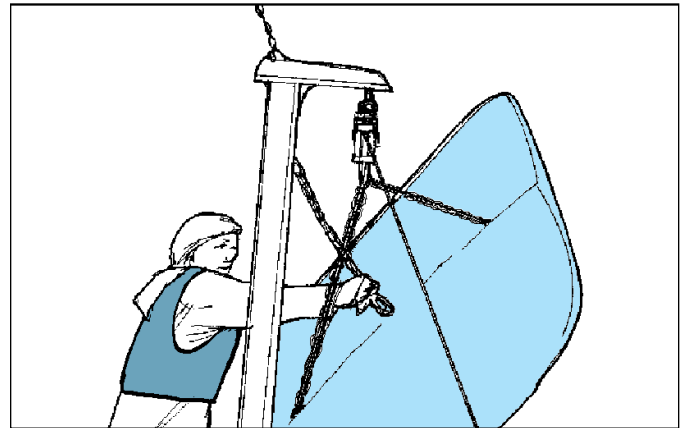

- Crew members **must** stay clear of the pinch points when hooking and unhooking the trawl doors from the davits. Serious injury will occur if a crew member is crushed between the doors and the side of the vessel.

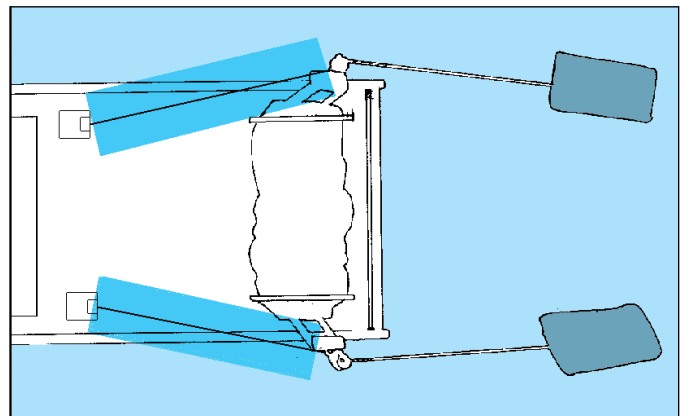

- Stay clear of the trawl warps when they are being set out. If a warp snaps, the line could strike a crew member.

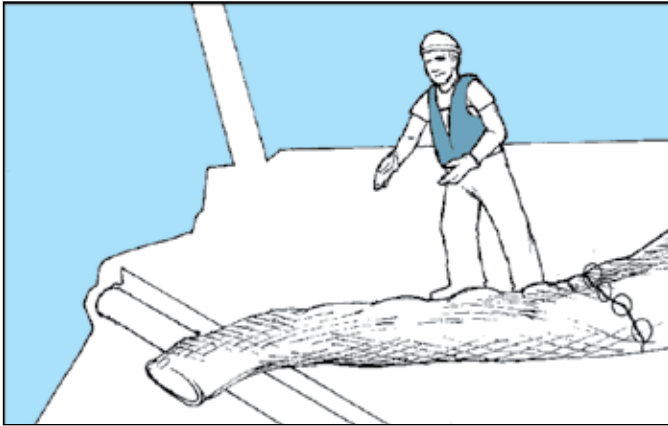

- Stay clear of the splitting strap when heaving the cod end over the stern. This lessens the chance of being pulled overboard by getting caught in the bight of the splitting strap.

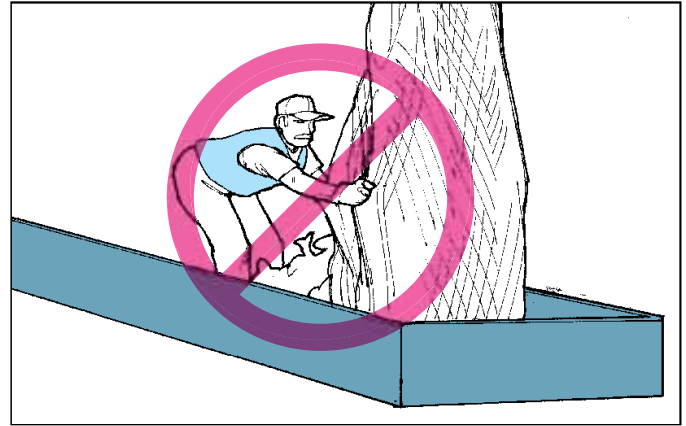

- Never stand in the checker when landing the bag of fish. You could be injured by fish spines or hit by the bag if it shifts.

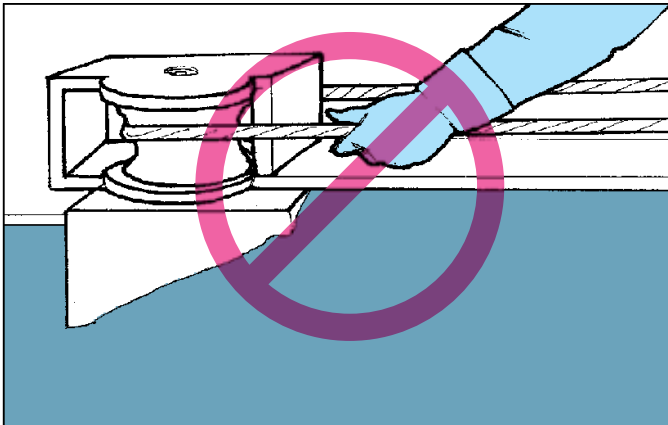

- Never handle a running line. Broken strands of wire rope can enter your hand and/or you may be pulled into a stationary block or other in-running nip point.

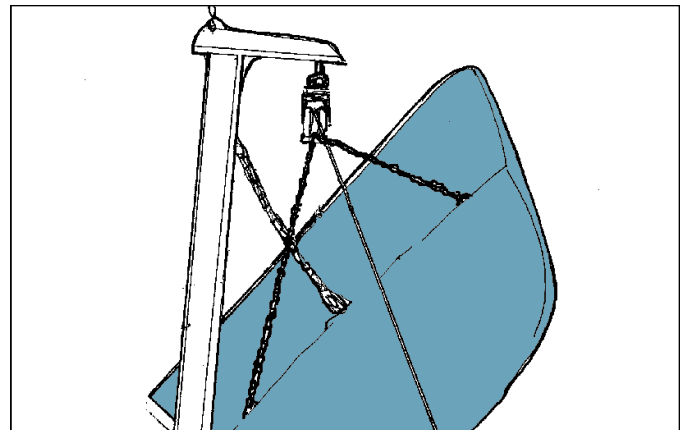

- When not being used, trawl doors and otter boards **must** be secured to davits.

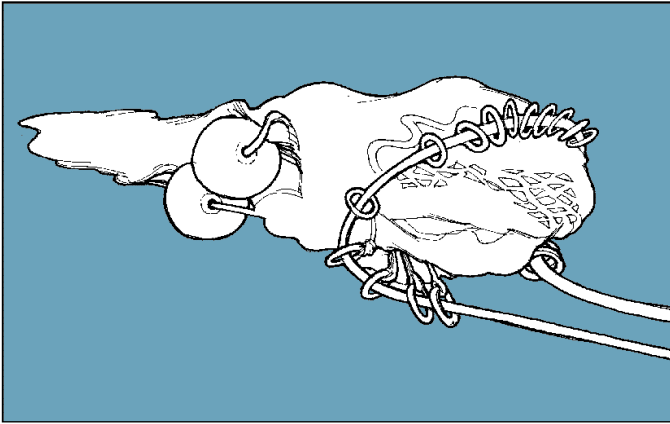

- All cod ends **must** have splitting straps so that fish can be dumped safely.

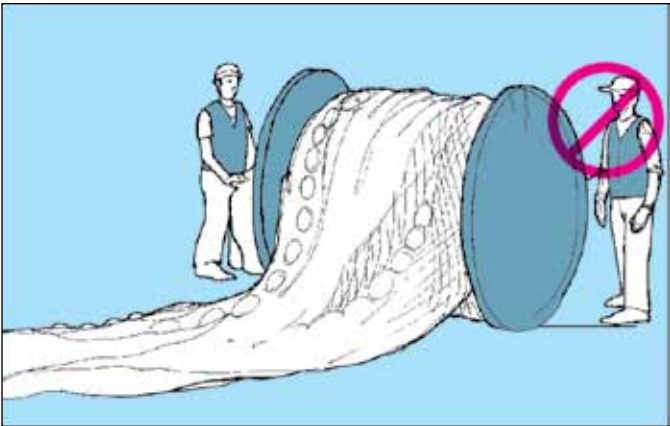

- Never stand forward of the drum when rolling the cod end onto the drum. If the cod end goes over the drum, it can land 2.4 metres (8 feet) or more ahead of the drum.

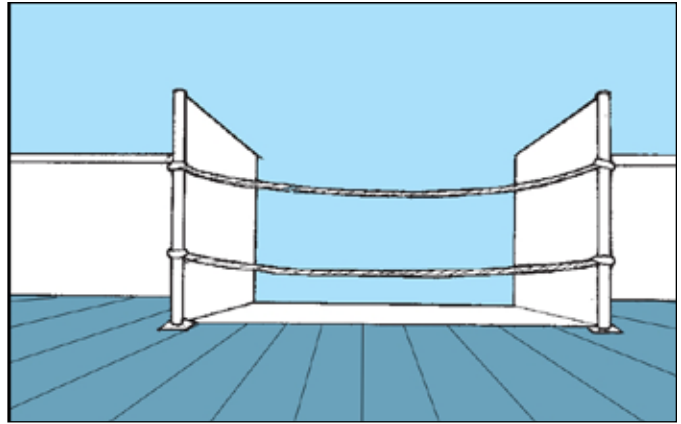

- Stern ramps **must** be roped off or guarded when not being used for trawling operations. If the ramps aren't guarded, crew members could accidentally fall down them.

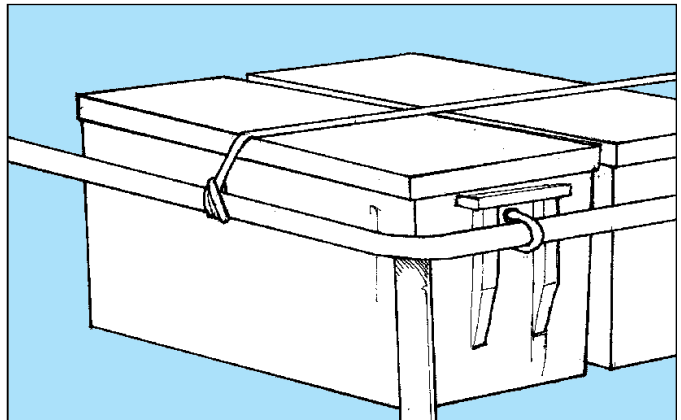

- Boxes for shrimp and fish **must** be secured with bolts, chains, tie-downs, and so on, to prevent them from sliding. If boxes slide, they can hit crew members or make the vessel unstable.

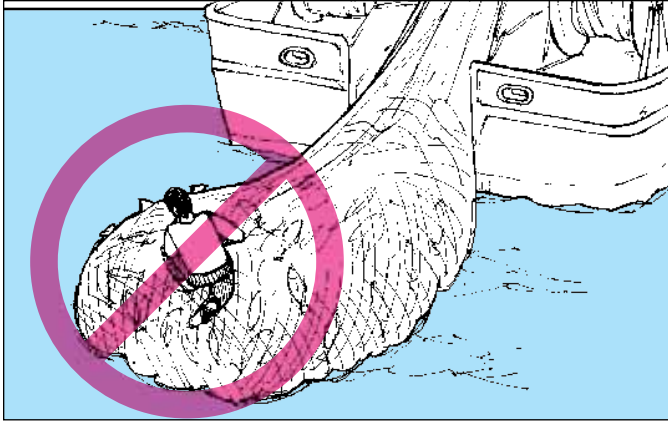

- Don't walk on the cod end while it is in the water.
- Be aware of the danger of getting pulled overboard or suffering a back injury when leaning overboard to split the lift.
- Stay clear of the lift as much as possible.
- Wear boots that will protect against rockfish spines, and don't kick fish on deck.
- Secure beams when trawling for shrimp. Beams **must** be secured when attaching or detaching plumb staffs. Unsecured beams may strike crew.

Tips from fishermen: otter trawl



- Make sure all crew are aware of danger zones when handling gear:
 - davit—door pinch points
 - trawl winch—pinch point in the spooling line
 - warp—high-tension running line
- Watch out for each other on deck, and remind each other to wear personal flotation devices and hard hats at all times.
- Avoid relying on just voice commands. Develop hand signals for the operation of all winches, and communicate to all crew members. Knowing just a stop signal is not good enough.
- Be aware of damaged gear if the net hangs up. Keep the deck area clear at critical points.
- Keep all access doors closed and dogs secure.
- Secure deck scuttles/manhole covers after each time they are opened to put fish down.
- Use extreme caution while trawling in bad weather. The net could get hung up on the bottom.

Tips from fishermen: beam trawl



- Handle the ratchet safely so the tooth that holds the sprocket doesn't come apart. Keep the ratchet well greased or it won't lock in properly.
- Use boom procedures for lifting the cod end so the boom doesn't swing out to the side and cause the vessel to roll over.
- Ensure the deadman pedal is always free and working. Don't use a locking device to keep it functioning—it needs to be able to disengage if there's a problem.
- Use tow line lifting procedures to prevent the transfer of weight to the tip of the boom to prevent rollover.
- Use the brake pedal when shooting the trawl to slow down or stop the drum.
- Use a positive type of drum brake to quickly stop the drum in any of the following situations:
 - A backlash occurs
 - The drum speeds up uncontrollably while setting in a heavy swell
 - The beam trawl tow line runs too fast

Safety steps and requirements for trolling include the following:



- When practical, wear sunglasses or safety glasses to protect your eyes from flying fish hooks. Hats with peaks, such as baseball hats, also offer some protection against flying hooks.

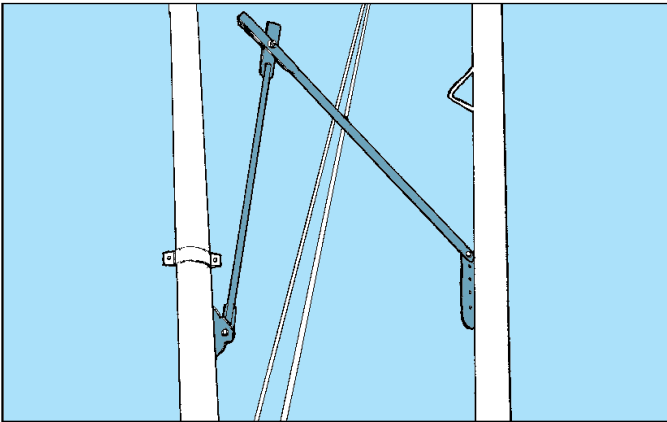

- Trolling and paravane stabilizer poles **must** have devices that lock the poles down and limit their downward travel. Unsecured poles that pop out of position can damage the vessel, make the boat unstable, or injure crew.

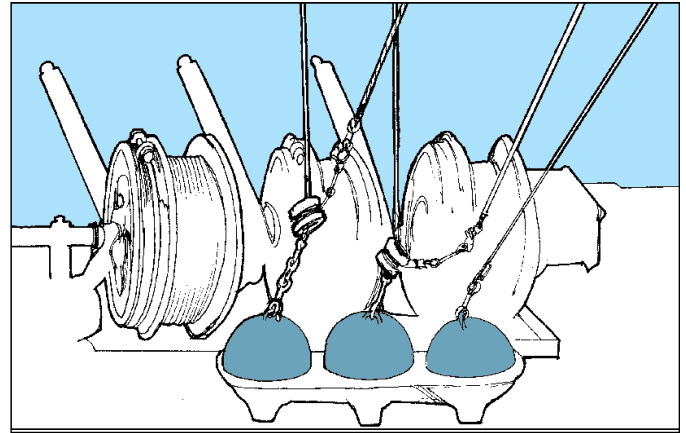

- Gurdy brakes **must** be kept in good working order. Crew **must** be able to stop the lines at all times.

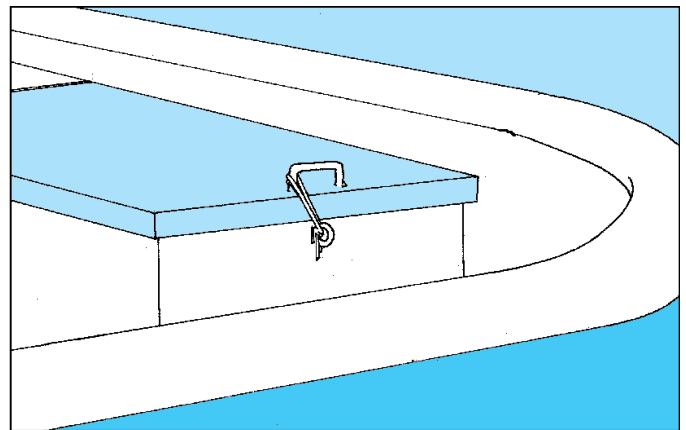

- Secure cockpit covers. Cockpits **must** have covers that can be secured in bad weather. Without secured covers, water can enter the cockpit, causing stability problems.
- Ensure any drains from interior spaces to the cockpit are fitted with one-way valves to prevent down-flooding.
- Be careful lifting paravanes (stabilizers) when putting them out. It's best to have two or more people to lift the paravanes, if possible. Stand clear of the paravane chain so your leg doesn't get caught in it.

- Inspect trolling wire for kinks and broken strands. These can lead to wires snapping and injuring crew members.
- Throw your hooks in the water before snapping onto the trolling wire. This way, you'll avoid getting snagged by hooks on a moving, descending trolling wire.
- When lifting cannon balls, feather the hydraulic lever very carefully so that the ball won't hit the block—or you.
- Don't try to pick a rat's nest loose when the cannon ball is hanging overboard. Secure the troll wire first.
- Make sure the gurdy levers are off and the brake is on when fishing is over and the cannonballs are in their holders. This prevents the gurdies from being engaged accidentally.

Tips from fishermen:



- When fishing alone, always take the boat out of gear when transferring from the cockpit to the wheelhouse or when performing other station transfers.
- Feather the direction valve to ensure proper direction of troll gurdies.
- Take a moment every hour or so to stretch the tendons of the forearms while dressing fish or unsnapping gear to prevent carpal tunnel syndrome.
- Wear sunglasses or protective glasses while pulling troll gear—lures can be spit back on a person's face at great velocity.
- Place small amounts of reflective tape all around the boat for visibility, especially at the ends of trolling poles.

Claims, Investigations and Insurance

WORK SAFE BC
WORKING TO MAKE A DIFFERENCE

FISHING INCIDENT INVESTIGATION REPORT

Submitted to the Master or Owner of the vessel for the purpose of documenting the investigation

WORK SAFE BC
WORKING TO MAKE A DIFFERENCE

FIRST AID RECORD

Sequence number

WORK SAFE BC
WORKING TO MAKE A DIFFERENCE

WORKER'S REPORT OF INJURY OR OCCUPATIONAL DISEASE TO EMPLOYER

Section 63(3) of the *Workers Compensation Act* requires that, where a worker is fit, and on request of the employer, they must provide the employer with particulars of the injury or occupational disease on a report prescribed by WorkSafeBC and supplied to the worker by the employer. This is the report prescribed.

If required
This report

WORK SAFE BC
WORKING TO MAKE A DIFFERENCE

fish SAFE

EMPLOYER'S REPORT OF INJURY OR OCCUPATIONAL DISEASE – FISHING

As an employer (master/owner), the *Workers Compensation Act* requires you to submit this report **within three days** of an injury to one of your workers, even if you disagree with the claim. By submitting your report promptly, you avoid penalties and delays in the form, and submit it by **FAX or MAIL**. The *Workers Compensation Act* requires that an employer (master/owner) submit this report in addition to form 7F. For additional information on your reporting responsibilities, go to [www.worksafebc.com](#).

CLAIMS CALL CENTRE
Phone 604 231-8888
Toll-free 1 888 967-5377
M-F, 8:00 a.m. to 4:30 p.m.

FAX
604 233-9777
Toll-free 1 888 922-8807

MAIL
WorkSafeBC
PO Box 4700 Stn Terminal
Vancouver BC V6B 1J1

Vessel master/owner information

Vessel master/owner's name
Address line 1
City
Province/state
Country (if not Canada)
Vessel master/owner phone (please include area code)
Extension
Vessel master/owner fax

Type of fishery at time of incident:
Dive (702005) Trawl (702009) Packer (702010)
Seine (702008) Gillnet/troll (702006) Other (please specify)
Longline/trap (702007)

Is there another contact for documentation of earnings (accountant, settlement service, etc.)? Yes No If yes, earnings contact last name
Earnings contact phone (please include area code):
Earnings contact extension:

Worker information

Worker last name
First name
Date of birth (yyyy-mm-dd)
Home phone number (please include area code)
Business phone number (please include area code)
Business extension
Address line 1
Address line 2
City

1. At the time of injury, was the worker (please check all that apply)
Fisher Full time New entrant to workforce Self-employed
Permanent Part time Principal/partner or relative of employer Casual
Temporary Student Hired on a contract basis

2. Does worker need an interpreter? Yes No 3. Preferred language
4. Dominant hand Left Right

Incident information

6. Date and time of incident (yyyy-mm-dd) a.m. p.m. OR 7. Period of exposure From
8. Describe how the incident happened 9. Describe the injury/illness
10. Did the injury(ies) or exposure result from a specific incident? Yes No 11. Side of body
12. Describe the work incident location (city or nearest port location) and where incident occurred (e.g. bow, stern)

6A

7F
WORKERS' COMPENSATION BOARD

ATTENTION BC FISHERMEN

DO WE HAVE YOU COVERED?

WORK SAFE BC

Who is covered by WorkSafeBC?

With very few exceptions, all workers in the province of British Columbia are covered by WorkSafeBC.



In the case of an injury, a crew member, master, or vessel owner who actively participates in the catching and landing of fish in B.C. is generally covered by WorkSafeBC.

Consult the WorkSafeBC brochure *Attention BC Fishermen—do we have you covered?* for more information about:

- When you are covered if you are injured
- When you are not covered if you are injured
- When a vessel owner registers and pays assessments
- When you need Personal Optional Protection (POP), the optional coverage for vessel owners and spouses
- Other frequently asked questions

The brochure is available online at www.worksafebc.com/publications/health_and_safety/by_topic/assets/pdf/attention_fishermen.pdf.

Reporting accidents to WorkSafeBC

Any accident that kills or seriously injures a crew member **must** be reported to WorkSafeBC's Prevention Line. Call 604 276-3100 or 1 888 621-7233 during regular office hours. After hours, call 604 273-7711 or 1 866 922-4357.

Serious accidents and injuries that required medical treatment or had the potential for causing a serious injury to a crew member **must** be investigated. The Fishing Incident Investigation Report (Form 52E40F) was developed to help you complete an incident investigation report.

For more information on this form and how to use it, see "A guide to completing the WorkSafeBC Fishing Incident Report" (Form 52E40F) at the end of this section.

Additionally, an Employer's Report of Injury or Occupational Disease—Fishing (Form 7F) **must** be submitted to WorkSafeBC:

- Within 10 days of the injury if the injury occurs at sea
- Within 3 days of the injury if the injury occurs elsewhere
- Immediately in the case of death
- Within 3 days of receiving information of a disabling industrial disease

In addition to serious injuries or injuries resulting in death, a Form 7F **must** be submitted to WorkSafeBC if:

- The crew member loses consciousness following the injury
- The crew member is taken or directed by the first aid attendant to go to the hospital or other medical treatment centre
- The injury is one that obviously requires medical treatment

- The crew member states an intent to seek medical treatment
- The crew member has received medical treatment for the injury
- The crew member is unable or claims to be unable to return to his or her usual job on any given day subsequent to the day of injury
- The injury or accident resulted or is claimed to have resulted in the breakage of an artificial member, eyeglasses, dentures, or hearing aids
- The worker or WorkSafeBC requests that Form 7F be sent to WorkSafeBC

If a first aid attendant treats the injured crew member, be sure to include a completed First Aid Report (Form 55B23) along with Form 7F.

Tips for easier reporting of accidents

Generally, the master **must** notify the owner of an injury or accident, and either the owner or the master **must** report and/or submit the appropriate forms to WorkSafeBC.

WorkSafeBC accepts faxes of reports. The contact information is located on the first page of the form. If you need forms, call 604 279-7448 (for the Lower Mainland) or 1 800 661-2112, local 7448. For copies of the Fishing Incident Investigation Report (Form 52E40F), the Employer's Report of Injury or Occupational Disease—Fishing (Form 7F), or other compensation related forms go to www.worksafebc.com/forms/default.asp.

Filing a claim

Are you a crew member who was injured at work? Have you missed time at work as a result? If so, you **should** report your injuries to WorkSafeBC by either calling our Teleclaim Contact Centre (1 888 WORKERS) or by completing and filing an Application for Compensation and Report of Injury or Occupational Disease (Form 6).

Are you a master or owner of a fishing vessel? Was a crew member injured at work? If so, report the injuries to WorkSafeBC by either calling our Teleclaim Contact Centre or by completing and filing an Employer's Report of Injury or Occupational Disease—Fishing (Form 7F).

Call 604 279-7448 (for the Lower Mainland) or 1 800 661-2112, local 7448 to request copies of forms, or go to www.worksafebc.com/forms/default.asp.

Forms include:

- Employer's Report of Injury or Occupational Disease—Fishing (Form 7F)
www.worksafebc.com/forms/assets/PDF/7F.pdf
- Application for Compensation and Report of Injury or Occupational Disease (Form 6, worker's report)
www.worksafebc.com/forms/assets/PDF/6.pdf
- First Aid Record (Form 55B23)
www.worksafebc.com/forms/assets/PDF/55B23.pdf
- Fishing Incident Investigation Report (Form 52E40F)
www.worksafebc.com/forms/assets/PDF/52E40F.pdf or www.fishsafebc.com

Teleclaim contact centre

Call 1 888 WORKERS to report a work-related injury. Teleclaim Contact Centre representatives can help you complete an injury report, understand the claim process, and access services to assist in recovery and return to work.

Who should call?

Any B.C. master or crew member who has been injured at work and who has missed work time as a result **should** call Teleclaim to report his or her injury to WorkSafeBC.

What is the number?

Call 1 888 WORKERS (1 888 967-5377) or #5377, for Telus, Rogers, and Bell mobility customers.

When can I call?

Teleclaim hours are Monday to Friday, 8:00 a.m. to 6:00 p.m.

What should I expect?

When you call Teleclaim, you will hear a series of instructions. Please listen carefully so that you can access the right WorkSafeBC representative.

- To access WorkSafeBC's 24-hour inquiry line, press 1.
- To start a new claim (application for compensation), press 2.
- If you already have a claim with WorkSafeBC, and wish to get decision information, have your claim number ready.
- If you already have a claim with WorkSafeBC, and wish to get payment information, have your claim number and personal access number (PAN) ready.

- If you know the extension of the person you're trying to reach, press 4.
- If you know the specific nature of your injury:
 - Press 4 for occupational disease, inter-jurisdictional, or hearing loss claims
 - Press 5 for disability awards and pension claims
- If you're unsure about the nature of your injury, press 0, or simply stay on the line to connect with a compensation services representative.

Order Teleclaim materials

Order the following materials featuring the Teleclaim phone number, free, to distribute in your workplace:

Poster

The poster is also available in Chinese, Filipino/Tagalog, Punjabi/Hindi, Spanish, and Vietnamese.



Wallet card

The wallet card is also available in Punjabi, simplified Chinese, traditional Chinese, and Spanish.



Order from www.worksafebcstore.com.

Assistance with claims

Fish SAFE

Fish SAFE provides assistance with the claims process on request by acting as a liaison between the injured workers, individual vessel owners, fish buyers, and WorkSafeBC case managers. Fish SAFE also works with vessel owners by encouraging them to actively manage claims.

Fish SAFE provides an Orientation to the Fishing Industry workshop to WorkSafeBC claims staff and others that work with the fishing industry.



Contact Fish SAFE for more information:

- 604 261-9700 or gina@fishsafebc.com
- www.fishsafebc.com

United Fishermen and Allied Workers Union

The UFAWU-CAW provides claims assistance to fishermen at both the New Westminster and Prince Rupert offices.



UNITED FISHERMEN AND ALLIED WORKERS' UNION

Contact the UFAWU-CAW in New Westminster at 604 519-3630 or in Prince Rupert at 250 624-6048.

Workers' advisers office

Workers' advisers are independent of WorkSafeBC and can assist and advise you on WorkSafeBC benefits, policies, and the interpretation of the *Workers Compensation Act*. Advisers can also provide you with direct assistance involving claim problems with WorkSafeBC, and provide representation in cases involving complex legal, medical, or policy issues.

Contact information for a Workers' Advisers Office near fishing communities can be found in Appendix D, or visit the website at www.labour.gov.bc.ca/wab.

Fishing incident investigation report

It is a regulatory requirement to investigate incidents. Failure to conduct an incident investigation can lead to order(s) on an inspection report, warning letter(s) and penalties.

Masters/owners **must** investigate:

- Any serious incident, injury, or fatality
- Incidents that resulted in injury requiring medical treatment
- Incidents that did not involve injury or involved only minor injury not requiring medical treatment, but had the potential for causing serious injury to a worker

The main purpose of doing an investigation is to identify factors that caused the incident, and to put procedures in place to reduce or remove the risk of it happening again.

An investigation also helps you and your crew to process the incident, making you better able to deal with the trauma. The investigation form assists you in doing this by creating the opportunity for you and your crew to sit down and discuss the incident and to find ways to reduce the chances of it occurring again.

WorkSafeBC and Fish SAFE have developed the Fishing Incident Investigation Report (Form 52E40F) to help you complete an incident investigation report. The template can be found at www.worksafebc.com/forms/assets/PDF/52E40F.pdf.

See the guide to completing the form on the next page.

A guide to completing the WorkSafeBC Fishing Incident Investigation Report (Form 52E40F)

Let's take a walk through a real-life example:

While a seiner is drumming back, the drum man walks over and removes the tow hook and throws it over the drum. He then walks over to the drum and flips the strap under the drum line. As it is coming in, his sleeve gets caught and throws him around the drum twice before someone can reach the drum controls.

Now complete the investigation report to help you focus on prevention of the incident in the future.

WORK SAFE BC WORKING TO MAKE A DIFFERENCE		FISHING INCIDENT INVESTIGATION REPORT			
<p>NOTE: This form is provided to the Master or Owner of the vessel for the purpose of documenting the investigation into a fishing incident. Please attach a separate sheet if necessary.</p>					
<p>Prevention Call Centre Phone 604 276-3100 Toll-free 1 888 621-SAFE (7233)</p>		<p>After-hours health and safety emergency 604 273-7711 Toll-free 1 866 922-4357 (WCB-HELP)</p>		<p>Fax 604 276-3247 Toll-free 1 866 240-1434</p>	
<p>Mail Prevention Support Services WorkSafeBC PO Box 5350 Stn Terminal Vancouver BC V6B 5L5</p>					
Master/owner contact information					
Master's name			Owner's name (if different from Master)		
Mailing address			Mailing address		
City	Province	Postal code	City	Province	Postal code
Master's phone number (include area code)			Owner's phone number (include area code)		
Master's fax number (include area code)			Owner's fax number (include area code)		
Master's email			Owner's email		
Other contact number (include area code)			Other contact number (include area code)		
Master's certification (certificate type)		Issuance date (yyyy-mm-dd)	Owner's certification (certificate type)		Issuance date (yyyy-mm-dd)
Vessel information					
1. Vessel name			2. VRN/CFV number		
3. What fishery was the vessel involved in?					
Species		Gear type		Other (specify)	
Incident information					
4. Date and time of accident/incident (yyyy-mm-dd)				a.m. <input type="checkbox"/> Approximate? p.m. <input type="checkbox"/> Yes <input type="checkbox"/> No <input type="checkbox"/>	
5. Location on the vessel (i.e. at the winch, stern, starboard side, hatch, etc.)					
6. Location of the vessel (name of area, latitude and longitude, i.e. 5 miles east of Boat Harbour, Dundas Island)					
7. Nature of reportable event (check one only)					
Near miss <input type="checkbox"/> First aid <input type="checkbox"/> Medical treatment only (no time loss) <input type="checkbox"/> Worker injury (time loss) <input type="checkbox"/> Fatal <input type="checkbox"/>					
8. Type of loss (check any that apply)					
Collision <input type="checkbox"/>		Fire <input type="checkbox"/>		Grounding <input type="checkbox"/>	
Flooding <input type="checkbox"/>		Sinking <input type="checkbox"/>		Striking <input type="checkbox"/>	
				Capsizing <input type="checkbox"/>	
				Other (explain) <input type="checkbox"/>	
52E40F		 WORKERS' COMPENSATION BOARD OF B.C.		(R06/11) Page 1 of 3	

● **Master/Owner Contact Information**
– Fill out what you know.

● **Vessel information (parts 1-3)** – Fill in basic information about the vessel.

● **Incident Information (parts 4-8)** – Fill in basic information about the incident. Be sure to fill in all parts.

WORK SAFE BC
WORKING TO MAKE A DIFFERENCE

Fishing Incident Investigation Report (continued)

9. Names and positions of those injured in the incident		
Last name	First name	Job title (skiffman, diver, etc.)

10. Names of witnesses			
Last name	First name	Address	Phone number (include area code)

Incident description, statement of causes, and recommendations

11. Description of the sequence of events leading up to the incident
11a. Please attach extra sheet(s) if necessary and label "sequence of events leading up to the incident."
12. Description of the incident (include the state of the sea (light chop, calm, swells, etc.), state of the tide (ebbing, flooding), weather conditions (rain, wind, squall, clear, etc.), boat movements at time of incident, and any information to accurately describe the incident.)
12a. Please attach extra sheet(s) if necessary and label "description of incident."

52E40F  (R06/11) Page 2 of 3

• **Names (parts 9–10)** – Fill in the names of all people injured, as well as anyone who witnessed the incident.

Incident description, statement of causes, and recommendations

• **Events leading to the incident (part 11)** – This is where you **should** sit down with your crew or those involved in the incident and work through the questions. Describe the sequence of events leading up to the incident:

Left Campbell River the day before, travelled all night...

• **Description of incident (part 12)** Here’s an example of how this incident could be described:

Joe was walking toward the drum and went to flip the strap under the running line when it caught his sleeve and pulled him around the drum. He managed to keep the rest of his body from being wrapped, but went around twice before John, who was hooking up the end on the port side of the boat, heard him and shut off the hydraulics. We then released the break and unwound him. John got some ice out of the hold and we put it on his arm and covered him in a blanket. I called for assistance and we ran to. . . . An ambulance picked him up at the dock.

WORKSAFE BC
WORKING TO MAKE A DIFFERENCE

Fishing Incident Investigation Report (continued)

13. Contributing factors *(List any contributing factors, unsafe conditions, acts, or procedures that in any manner contributed to this incident.)*

13a. Please attach extra sheet(s) if necessary and label "additional accident causes."

14. Rough drawing and/or rough sketches of details

14a. Please attach extra sheet(s) if necessary and label "rough drawing and/or rough sketches of details."

15. Recommended corrective actions *(actions taken to prevent a recurrence of this type of accident)*

15a. Please attach extra sheet(s) if necessary and label "additional follow-up actions."

Name of person(s) who conducted investigation <i>(print)</i>	Signature(s)		
Name of person who completed report <i>(print)</i>	Signature	Date <i>(yyyy-mm-dd)</i>	

For WorkSafeBC use only

Officer and number	Region	Area	Date received <i>(yyyy-mm-dd)</i>
--------------------	--------	------	-----------------------------------

The Workers Compensation Act requires the employer (Master/Owner) to complete and submit a Fishing Incident Investigation Report, in addition to the Employer's Report of Injury or Occupational Disease — Fishing (Form 7F). For additional information on your reporting responsibilities, please refer to our web site at WorkSafeBC.com.
Personal information on this form is collected for the purposes of administering a worker's compensation claim by WorkSafeBC in accordance with the Workers Compensation Act and the Freedom of Information and Protection of Privacy Act. For further information about the collection of personal information, please contact WorkSafeBC's Freedom of Information Coordinator at PO Box 2310 Stn Terminal, Vancouver BC, V6B 3W5, or telephone 604 279-8171.

52E40F  (R06/11) Page 3 of 3

Contributing factors (part 13)

Example:

- *The usual practice of flipping the strap under the running line may have become too routine, so there may have been less focus than necessary at the time, or something else may have been happening, like fewer than the usual number of crew men?*
- *Long sleeve jacket*
- *Other crew on deck not paying attention at the time*

Rough drawing (part 14) – Do your best.

Recommended corrective actions (part 15)

Example:

After discussion with the crew, it was determined that flipping the strap under the line was helpful when setting but not entirely necessary. Kind of a habit that we got into but never really assessed the risk. It was determined that we will no longer flip the strap under the drum running line because the risk outweighs the benefits. The drum man should always be briefed on potential risks to avoid getting caught in the bight or net when setting or drumming back.

Appendices



Appendix A: Injuries and claims in commercial fishing

Claims and employment, 2006 to 2010

From 2006 to 2010, the number of Fisher Registration Cards issued decreased by 22 percent, from 7,639 to 6,270. During the same five-year period, the number of time-loss claims decreased by 32 percent. Between 2008 and 2010, the number of Fisher Registration Cards increased by approximately 5 percent, while the number of time-loss claims increased by 2 percent. (See “Definitions” section at the end of this appendix.)

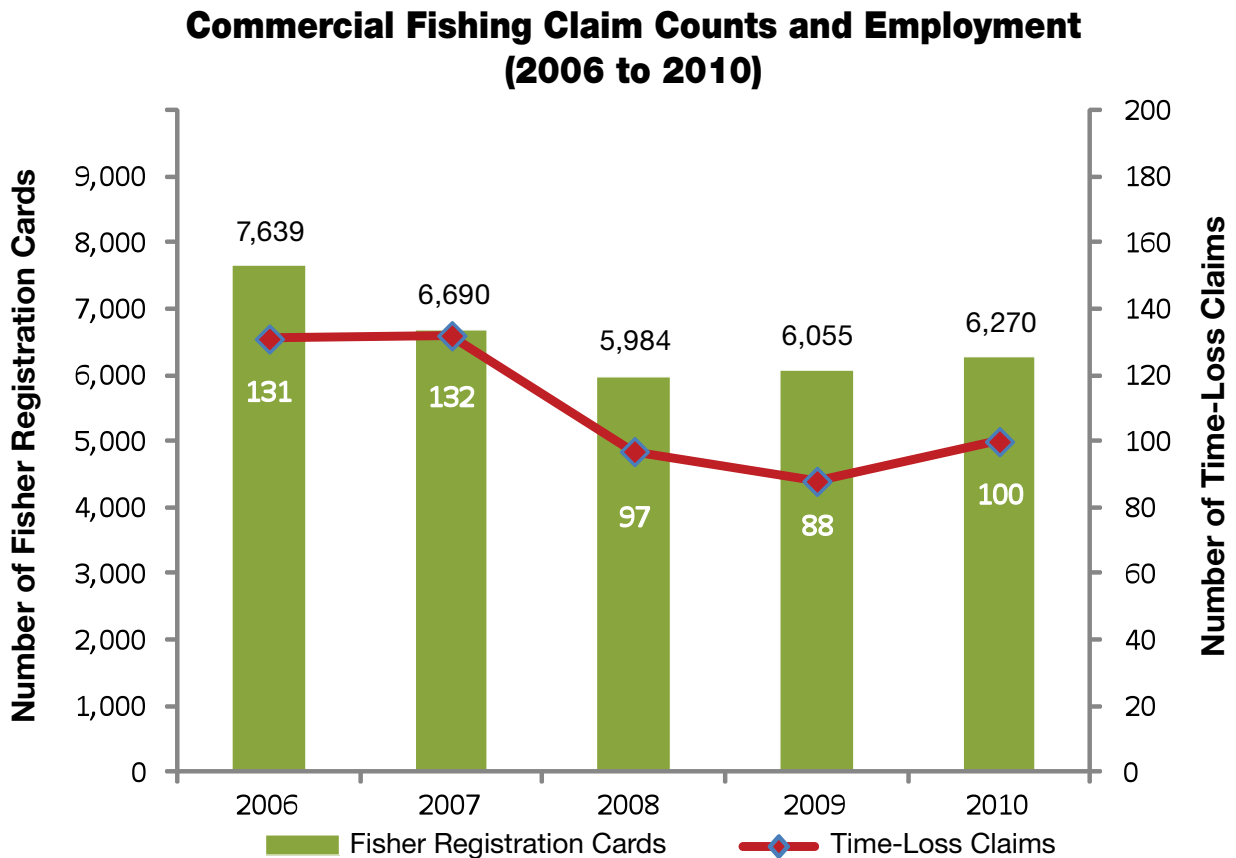

Note: Health Care Only claims are excluded

Prepared by: Business Information & Analysis (BIA), WorkSafeBC, 2011

Source: BIA Datamart, WorkSafeBC and Fisheries and Oceans Canada

Serious injury claims, 2006 to 2010

From 2006 to 2010, 380 commercial fishing-related serious injury claims were accepted by WorkSafeBC. During the same five-year period, the most common accident types that resulted in serious injuries included vessel accidents, fishermen being struck by an object, fishermen caught in or compressed by equipment, and overexertion. (See the “Definitions” section at the end of this appendix.)

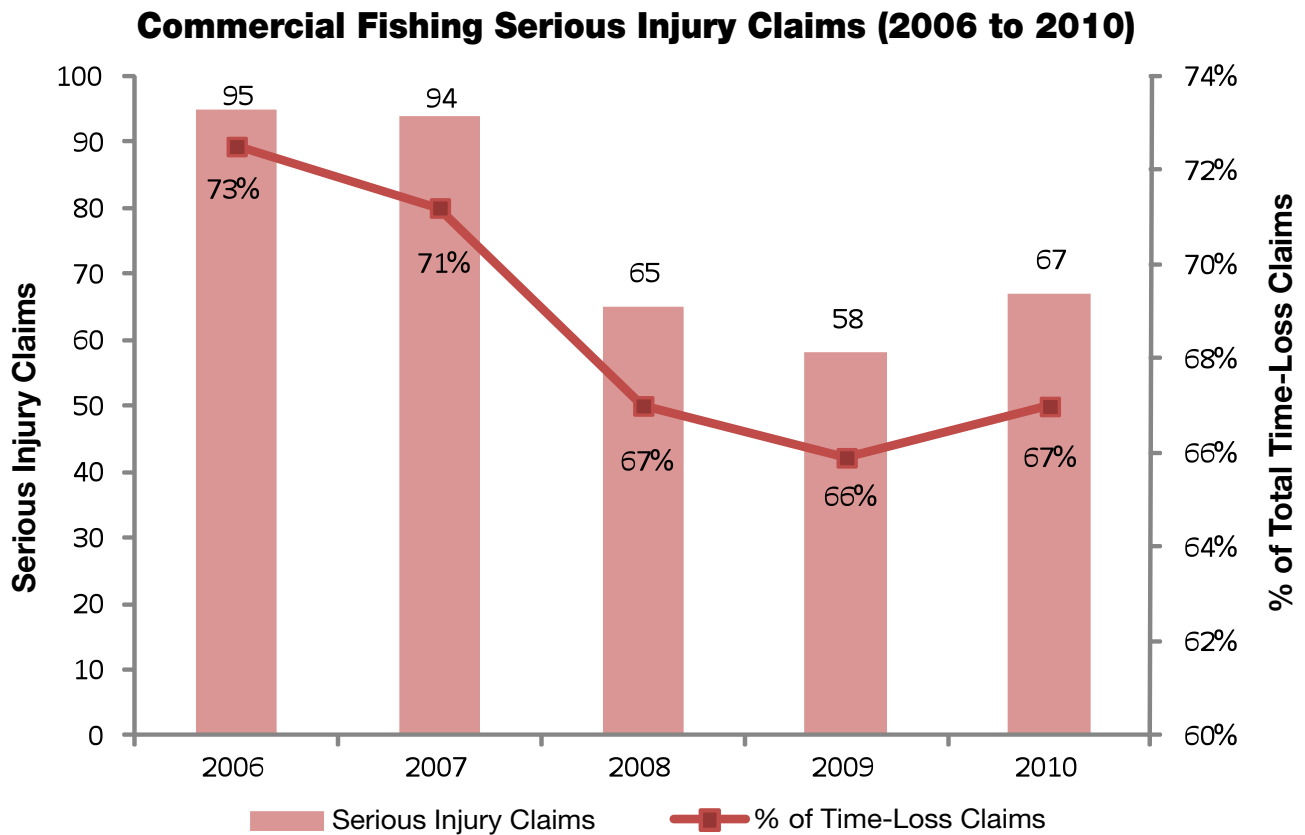

Prepared by: Business Information & Analysis (BIA), WorkSafeBC, 2011

Source: BIA Datamart, WorkSafeBC

Fatal claims, 2006 to 2010

From 2006 to 2010, 10 fatal commercial fishing-related claims were accepted by WorkSafeBC. A significant number of fatalities were from drowning. (See the “Definitions” section at the end of this appendix.)

Commercial Fishing Fatal Claims (2006 to 2010)

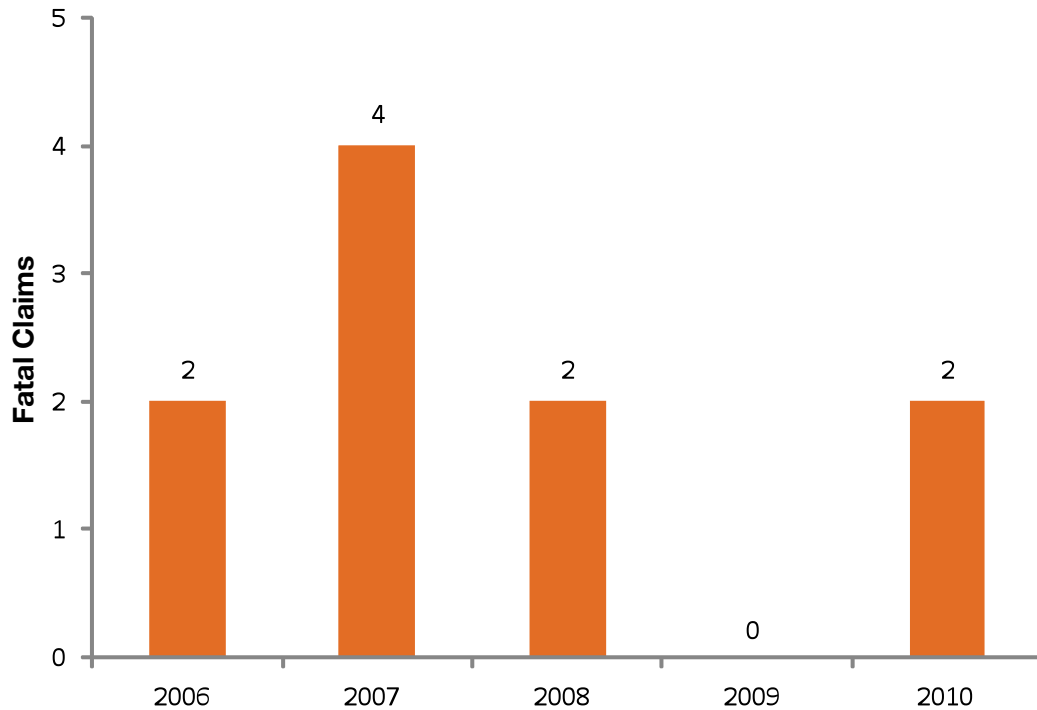

Accepted Year	Cause of Death	Claim Count
2006	Boat sank and worker drowned.	1
2006	Fishing vessel had just finished refueling and had pulled away from fueling dock when vessel exploded.	1
2007	Worker was struck in back by a trawling door.	1
2007	Worker fell overboard and drowned.	1
2007	Worker fell overboard and drowned.	1
2007	Worker died from medical complications (heart attack) arising from a previously compensable injury.	1
2008	Boat overturned and drowned.	1
2008	Securing cables in order to lock down a heavy side door. A cable snapped, causing a sister hook to fly through the air and hit worker on the head.	1
2010	Worker fell overboard and drowned.	1
2010	Struck by a log. Cause of death: urosepsis.*	1

* The result of a recurrence of infection from a decades-old injury.

Prepared by: Business Information & Analysis (BIA), WorkSafeBC, 2011

Source: BIA Datamart, WorkSafeBC

Definitions

Time-loss claims: The total number of time-loss claims. A time-loss claim must have a short-term disability (STD), long-term disability (LTD), or survivor benefit in the year of injury or in the three months following the year of injury.

Serious injury claims: A serious injury claim has a short-term disability (STD), long-term disability (LTD), or fatal benefit payment in the period consisting of the month of injury or the following three months. A serious injury claim has at least one of the following:

1. Twenty-eight or more STD days lost in the period.
2. Healthcare costs in the period equivalent to 28 days of STD costs.
3. A fatal benefit paid in the period.
4. One of the 275 International Statistical Classification of Diseases (ICD-9) codes that have been designated as "Serious Injuries." An ICD-9 code is a universal medical diagnosis code maintained by the World Health Organization (WHO).

Fatal claims: The number of accepted claims for which a first survivor benefit (fatal reserve or cash award) was awarded in the year, regardless of the year of injury.

Prepared by: Business Information & Analysis (BIA), WorkSafeBC, 2011

Source: BIA Datamart, WorkSafeBC

Appendix B: Sample vessel checklist

Vessel _____ Date _____ Voyage _____ Time _____

Item	Safe/ Complete	Comments	Date corrected
Established safe work procedures			
Established emergency procedures/duties			
Emergency drills (conducted)			
Crew training (complete)			
Vessel documentation (available)			
WHMIS documentation			
Material Safety Data Sheets (MSDSs)			
First aid supplies			
Emergency signals and flares			
Firefighting equipment			
Safety equipment:			
• Life raft(s)			
• Life jackets or personal flotation devices			
• Immersion suits			
Alarms and sensors			
Engine condition			
Bilge pumps and bilge condition			
Electrical systems			
Fuel and fuel systems			
Fishing equipment			
Electronic equipment: radar/sonar/plotter			
Radio equipment			
Navigation lights, shapes			
Charts, instruments			
Compass and deviation card			
Log book			
Sailing or trip plan			
Notification of trip changes			

Appendix C: Conducting a risk assessment in commercial fishing

Risk assessments allow the owner, operator, and crew to assess potential hazards in a formal, proactive manner. A risk assessment will identify existing and potential hazards, and allow these hazards to be mitigated. This will decrease potential incidents and equipment failure, both of which can result in crew injuries and loss of valuable fishing time.

The table below shows the “hierarchy of controls,” with eliminating the hazard as the most desired resolution for addressing a hazard, and using personal protective equipment as the least desirable resolution.

Hierarchy of Controls

Most effective



1. Eliminate

- Human interaction in the process
- Pinch points (deck layout)



2. Substitute

- Automated processes
- Substitute a hazardous chemical for a less hazardous chemical



**3. Engineering controls
(safeguarding technology)**

- Barriers
- Interlocks/hold-to-run controls
- Two-hand controls
- Mechanical hard stops (for example, spooling gear stops)



4. Administrative controls

- Lights, beacons, and strobes
- Signs
- Restricted space painted on deck
- Horns
- Labels (for example, to identify controls)
- Safe job procedures
- Safety equipment inspections
- Training
- Lockout



5. Personal protective equipment

- Safety glasses
- Hearing protection (earplugs/muffs)
- Face shields
- Gloves
- Personal flotation devices (PFDs)
- Immersion suits

Least effective

The following matrix will help you to determine the level of risk a particular task may have (Severity × Likelihood). The goal of the process is always to eliminate or lower the risk. This may be accomplished by reviewing and implementing the appropriate controls as outlined in the previous table. Once the “fix” has been implemented, re-evaluate the task to see if it now falls to an acceptable level.

Severity x Likelihood Matrix

		HAZARD SEVERITY				
		Negligible (1)	Slight (2)	Moderate (3)	High (4)	Very high (5)
LIKELIHOOD OF OCCURRENCE	Very Unlikely (A)	LOW	LOW	LOW	LOW	MEDIUM
	Unlikely (B)	LOW	LOW	LOW	MEDIUM	MEDIUM
	Possible (C)	LOW	LOW	MEDIUM	MEDIUM	HIGH
	Likely (D)	LOW	MEDIUM	MEDIUM	HIGH	HIGH
	Very Likely (E)	LOW	MEDIUM	HIGH	HIGH	HIGH

Contact a WorkSafeBC occupational safety officer for more information on how to conduct a risk assessment.

Appendix D: For more information

WorkSafeBC

For a list of WorkSafeBC offices, see inside the back cover of this manual.

Visit our website at www.worksafebc.com (click on “Safety at Work” to find commercial fishing).

WorkSafeBC Prevention Line

In the Lower Mainland: 604 276-3100

Toll-free elsewhere in B.C.: 1 888 621-7233

Link to the Occupational Health and Safety Regulation:

www2.worksafebc.com/publications/OHSRegulation/Home.asp

Transport Canada

Link to Transport Canada Marine Safety Regulations:

www.tc.gc.ca/eng/marine-menu.htm

Link to Small Fishing Vessel Safety manual:

www.tc.gc.ca/eng/marinesafety/tp-tp10038-menu-548.htm

Link to Small Commercial Vessel Safety guide:

www.tc.gc.ca/eng/marinesafety/tp-tp14070-menu-1648.htm

Fish SAFE

Fish SAFE is a fishing industry program administered by the BC Seafood Alliance. On behalf of the fishing industry, Fish SAFE coordinates and develops safety tools, safety awareness, and safety advocacy. All programs are developed and driven by fishermen for fishermen for the purpose of reducing injuries and fatalities.



Contact Fish SAFE:

2-11771 Horseshoe Way
Richmond, BC V7A 4V4

Phone: 604 261-9700

Fax: 604 275-7140

Website: www.fishsafebc.com

Workers' Advisers Offices (WAO)

WAO is an organization that offers advice, education, and representation to workers, their dependents, and other stakeholders for fostering safe and healthy workplaces. WAO's mission is to work toward a system of workers' compensation that serves the needs of workers, their dependents and other stakeholders, in a timely, responsive, innovative, and accountable manner.

The following are WAO offices near fishing communities. (Additional Workers' Advisers Offices are located in Kelowna, Kamloops, Nelson, and Prince George.) If you live outside the areas listed here, call the number closest to you for assistance with your claim or visit WAO's website at www.labour.gov.bc.ca/wab.

Vancouver/Lower Mainland

Lower Mainland

500-8100 Granville Avenue
Richmond, BC V6Y 3T6
Phone: 604 713-0360
Toll-free: 1 800 663-4261
Fax: 604 713-0311

Abbotsford

204-32555 Simon Avenue
Abbotsford, BC V2T 4Y2
Phone: 604 870-5488
Toll-free: 1 800 663-4231
Fax: 604 870-5494

Vancouver Island

Victoria

403-3960 Quadra Street
Victoria, BC V8X 4A3
Phone: 250 952-4393
Toll-free: 1 800 661-4066
Fax: 604 952-4399

Nanaimo

504-495 Dunsmuir Street
Nanaimo, BC V9R 6B9
Phone: 250 741-5504
Toll-free: 1 800 668-2117
Fax: 250 741-5516

Campbell River

205-1040 Shoppers Row
Campbell River, BC V9W 2C6
Phone: 250 830-6526
Toll-free: 1 888 643-0013
Fax: 250 830-6528

WorkSafeBC offices

Visit our web site at WorkSafeBC.com.

Abbotsford

2774 Trethewey Street V2T 3R1
Phone 604 276-3100
1 800 292-2219
Fax 604 556-2077

Burnaby

450 – 6450 Roberts Street V5G 4E1
Phone 604 276-3100
1 888 621-7233
Fax 604 232-5950

Coquitlam

104 – 3020 Lincoln Avenue V3B 6B4
Phone 604 276-3100
1 888 967-5377
Fax 604 232-1946

Courtenay

801 30th Street V9N 8G6
Phone 250 334-8765
1 800 663-7921
Fax 250 334-8757

Kamloops

321 Battle Street V2C 6P1
Phone 250 371-6003
1 800 663-3935
Fax 250 371-6031

Kelowna

110 – 2045 Enterprise Way V1Y 9T5
Phone 250 717-4313
1 888 922-4466
Fax 250 717-4380

Nanaimo

4980 Wills Road V9T 6C6
Phone 250 751-8040
1 800 663-7382
Fax 250 751-8046

Nelson

524 Kootenay Street V1L 6B4
Phone 250 352-2824
1 800 663-4962
Fax 250 352-1816

North Vancouver

400 – 224 Esplanade Ave. W. V7M 1A4
Phone 604 276-3100
1 888 875-6999
Fax 604 232-1558

Prince George

1066 Vancouver Street V2L 5M4
Phone 250 561-3700
1 800 663-6623
Fax 250 561-3710

Surrey

100 – 5500 152 Street V3S 5J9
Phone 604 276-3100
1 888 621-7233
Fax 604 232-7077

Terrace

4450 Lakelse Avenue V8G 1P2
Phone 250 615-6605
1 800 663-3871
Fax 250 615-6633

Victoria

4514 Chatterton Way V8X 5H2
Phone 250 881-3418
1 800 663-7593
Fax 250 881-3482

Head Office / Richmond

Prevention Information Line:
Phone 604 276-3100
1 888 621-7233 (621-SAFE)

Administration:

6951 Westminster Highway
Phone 604 273-2266

Mailing Address:

PO Box 5350 Stn Terminal
Vancouver BC V6B 5L5

After Hours

Health & Safety Emergency

604 273-7711
1 866 922-4357 (WCB-HELP)

